



2024 LEAD APRON CATALOG

Forest Imaging is your exclusive distributor for top-quality Protech Medical radiation protection products designed specifically for healthcare professionals like you.



 406.551.5216

 info@ForestImaging.net

 www.ForestImaging.net

01

Lead Garments are worn by healthcare professionals to protect them from the harmful effects of x-ray radiation during procedures requiring the use of x-ray and fluoroscopy. Lead aprons are usually worn in combination with other radiation protective products to provide complete protection from x-ray exposure.



APRONS

QUALITY. SERVICE. INTEGRITY.

Protech's aprons are proudly hand-stitched in the USA with one collective mission: perfection. Our light-weight designs and ergonomic styles are the result of decades of manufacturing experience. Seamless finishes, clean stitching, and elegant curves are what make our aprons best-in-industry.

Fulfilling our commitment to high quality, our Proguard Aprons are made in the USA from locally sourced materials whenever possible. Protech follows the strict guidelines of the ISO Quality Management System and is approved to sell in major markets throughout the world.

MANUFACTURER

FDA LISTING

OWNER/OPERATOR #: 10025412

FDA LISTING NUMBER: D048258

PRODUCT CODE: IWO

DEVICE CLASS: #1

REGULATION #: 892.6500

OSHA REGULATION: 1910.1096

QUALITY SYSTEM

ISO 9001:2015

EU 2016/425, MODULE D, B



2895



0338



COMPLIANCE

Protech has expertly crafted radiation protective garments for over 20 years. Our extensive product knowledge incorporates high-quality control systems as well as comprehensive regulatory testing.



EN 61331-1:2014: (EU) Protective devices against Diagnostic Medical X-ray radiation. (Determination of attenuation properties of material)

EN 61331-3:2014: (EU) Protective devices against diagnostic medical X-radiation Part 3: Protective clothing, Eyewear and Protective Patient shields.

ASTM 2547-18: (USA) Standard test method for determining the attenuation properties in a primary x-ray beam of materials used against radiation.

2 YEAR WARRANTY

Protech's high quality garments ("Garments", aka PPE or Aprons) include; aprons, thyroid collars, gloves, dental aprons, reproductive aprons, and lead accessories. The Garments are warrantied to be free of defects in materials and workmanship to the original purchaser for 2 years.

Upon evaluation, Protech will either repair or replace the defective item or part without charge to the purchaser. This warranty is void when the product has been tampered with, when repairs or attempted repairs have been made by unauthorized persons, or when the item has been subject to misuse, abuse or damage in transit. No charges will be accepted or reimbursed for unauthorized parts, repairs or services.

APRON RETURNS, REPAIRS AND DISPOSAL

Please contact your local representative for return instructions. All returns, repairs, recoveries, or exchanges, regardless of reason, must be accompanied by an authorized RMA. Customer should make available the Purchase Order # or relevant sales information.

For disposals, You must dispose of lead garments by complying with local, state, federal and/or international regulations where applicable.

TAKING CARE OF YOUR APRON

It is important to establish a consistent, deep-cleaning schedule to mitigate the risk of pathogen transmission. Please clean the apron immediately **after each use**. You can clean most dirt and stains (blood, bodily fluids, barium contrast media) using room temperature water along with the following cleaning solutions: mild diluted soap, alcohol or ammonium-based wipes, and highly diluted Clorox hydrogen peroxide (not recommended for long term use as it results in degradation over time). To apply cleaning fluid, please use a cloth or wipe and always use room temperature water.

Please Note: If you're dealing with biohazardous materials, we recommend using an additional barrier (such as SMS gowns) to protect the apron.



Examples of Approved Cleaners

- PDI Sani-Cloth® AF3 Germicidal Disposable Wipes
- PDI Super Sani-Cloth® Germicidal Disposable Wipes
- CaviCide® wipes
- Alcohol and Ammonium based cleaners are strongly recommended
- Sodium Hypochlorite (bleach) cleaners, while acceptable, result in minor degradation over time

DO NOT

- Do not machine wash or dry your apron
- Do not use hot or warm water
- Do not iron or autoclave



STORAGE

When not in use, garments should be placed on a hanger or stored using Protech's apron storage equipment. Best places to store your apron: Valet racks, peg racks, apron hangers and closets. If a hanger is not available, lay flat on a surface. For transportation, garments should be carefully rolled up, not folded, and placed into a box or Protech duffle bag.

All of our apron storage options can be found at the end of the apron section.

Please do not fold the aprons for an extended period of time as this will increase the chances of the inner material creasing or cracking. Also, avoid contact with sharp objects since they may damage the garment's protective core material. Keep garment out of direct sunlight or prolonged exposure to high heat. Store at 70-80°F (21-27°C). Temperature limits approximately 60-100°F (16-38°C).



AVA's enterprise level technology can save you time and money by helping you effectively manage your inventory and annual inspections. For more information, refer to our AVA brochure or avacloud.com.



APRON ORDERING GUIDE



STEP 1:

CHOOSE YOUR APRON STYLE

We offer two types of aprons: Frontal and Full Protection.

As their names suggest, a Frontal apron only protects the front of your body, while a Full Protection apron offers both front, lateral, and back protection.

For a **lighter weight apron**, choose a Frontal style. Our most popular frontal apron is the Flexback apron but you can view all of our styles beginning on page 35.

For **greater protection**, choose a Full Protection apron. We recommend the Proguard Balance Vest and Skirt, which offers a balance of protection and comfort.

Other important factors that should be considered in choosing your apron style: procedure type, duration, body type and personal needs.



FRONTAL APRONS

Frontal aprons only have protection in the front but are far more forgiving than full protection aprons. They contain less protective material, so they tend to be **lighter and more flexible** than full protection aprons. They are a fantastic option for **short procedures where risk of lateral exposure is low** or when a garment is required but you are not nearby the beam (over 6 feet or in another room).. If you're looking for a reliable, lightweight frontal apron we **recommend the Flexback** style as a clear customer favorite.



WRAPAROUND APRONS

Our Wraparound full protection apron styles provide **maximum protection** from the front to the back and are **excellent for long procedures with high exposure**. They do contain more protective material and tend to be **heavier than frontal aprons**. Compared to other full protection styles (Vest Skirts), Wraparounds are usually **easier to don but do concentrate weight on the shoulders**. As a full protection apron, a **proper fit is crucial** for weight distribution and comfort. We offer a wide variety of customizations and add-ons to make your wraparound apron fit perfectly.

VEST SKIRT APRONS

Vest Skirt Aprons are best suited for those wanting **maximum protection during prolonged procedures with lateral/back exposure**. While they contain more protective material due to overlapping between the vest and skirt, they **eliminate up to 50% of the weight burden on the shoulders and provide more maneuverability**. Our wide variety of Vest styles can be tailored according to your needs and are optimized to reduce weight by up to 15%. A **proper fit is critical** to ensure optimum protection, comfort, and longevity. Check out our customizations and add-ons to build your perfect apron.

2

STEP 2:





CHOOSE YOUR CORE MATERIAL & THICKNESS

Each core material varies in composition, weight and level of protection. Higher core material thicknesses result in more protection but also increase weight. The protection thickness of your garment, expressed as lead equivalence (LE), should be determined by your duration of exposure to x-ray and the intensity of the beam. The most critical factor is duration. For short, simple procedures utilizing lower kV beam intensities, 0.35mm LE may be suitable. Whereas 0.50mm LE should be used during long procedures regardless of beam intensity.

Protech's thickness options are 0.25, 0.35, and 0.50mm LE with .50mm* and .35mm* LE being the most popular. We offer additional options upon request such as .75mm and 1.00mm. **Standard protection for lead garments is 0.50mm in the front and 0.25mm in the back.** For other product types such as dental aprons and some lead accessories, standard lead equivalences may vary.





ASTM & IEC CERTIFIED

Standard Lead Prolite Bilayer IEC



ASTM CERTIFIED

Prolite Premier Nano



CORE MATERIAL THICKNESS OPTIONS

0.25

Lightest

Attenuates from
86-91% @ 90kV

0.35

Optimal

Attenuates approx.
94% @ 90kV

0.50

Standard

Attenuates approx.
97% @ 90kV

*Please be advised that some state or country requirements may be specific about what thicknesses are permitted.



3

STEP 3: CHOOSE YOUR FABRIC COLORS

You will need to choose colors for the exterior, interior and binding thread of your apron. Need a fabric that performs? Consider our anti-microbial, Satinguard fabrics for an easy-to-clean option. You can view our fabric color options on pages 73-79.

If you have your own fabric that you'd like to use, we can accommodate! Just take a look at this Louis Vuitton apron; a special request by one of our customers.



4

STEP 4: CHOOSE CUSTOMIZATIONS

Depending on your apron style, you'll have a variety of customization options to choose from. Some examples: Embroidery, axillary wings, logos, extra pockets, etc.

CORE MATERIALS

Knowing what's inside your apron is as important as how that apron claims to protect you. So here comes the boring (but oh so necessary) part.

Diagnostic imaging exposes personnel most prominently to x-ray energy in the 50 – 150kV range. Each metal used in your product to block x-ray provides specialized protection at certain kVs. Lead (Pb) has become the industry standard for radiation protection because it efficiently protects across the entire kV range (50kV – 150kV). The catch? It's heavy and toxic to the environment. Other common metals used for radiation protection are: Antimony, Barium, Cerium, Tungsten and Bismuth. The problem is, they protect at specific ranges. Antimony (Sb) and barium (Ba) provide more efficient attenuation of the photon spectrum below the K-edge window of lead (35 – 90kV), while higher Z elements like tungsten (W) and bismuth (Bi) are more efficient for stopping higher energy radiation (>90 kV).

Each Proguard core material is carefully formulated to more efficiently attenuate portions of the photon spectrum and limit “gaps” in protection due to over-reliance on individual x-ray protective elements. Protech utilizes proper elemental balance to address k-edge concerns for key diagnostic imaging ranges. Protech's advanced elastomers exhibit the best balance of toughness, flexibility, durability and cracking resistance.

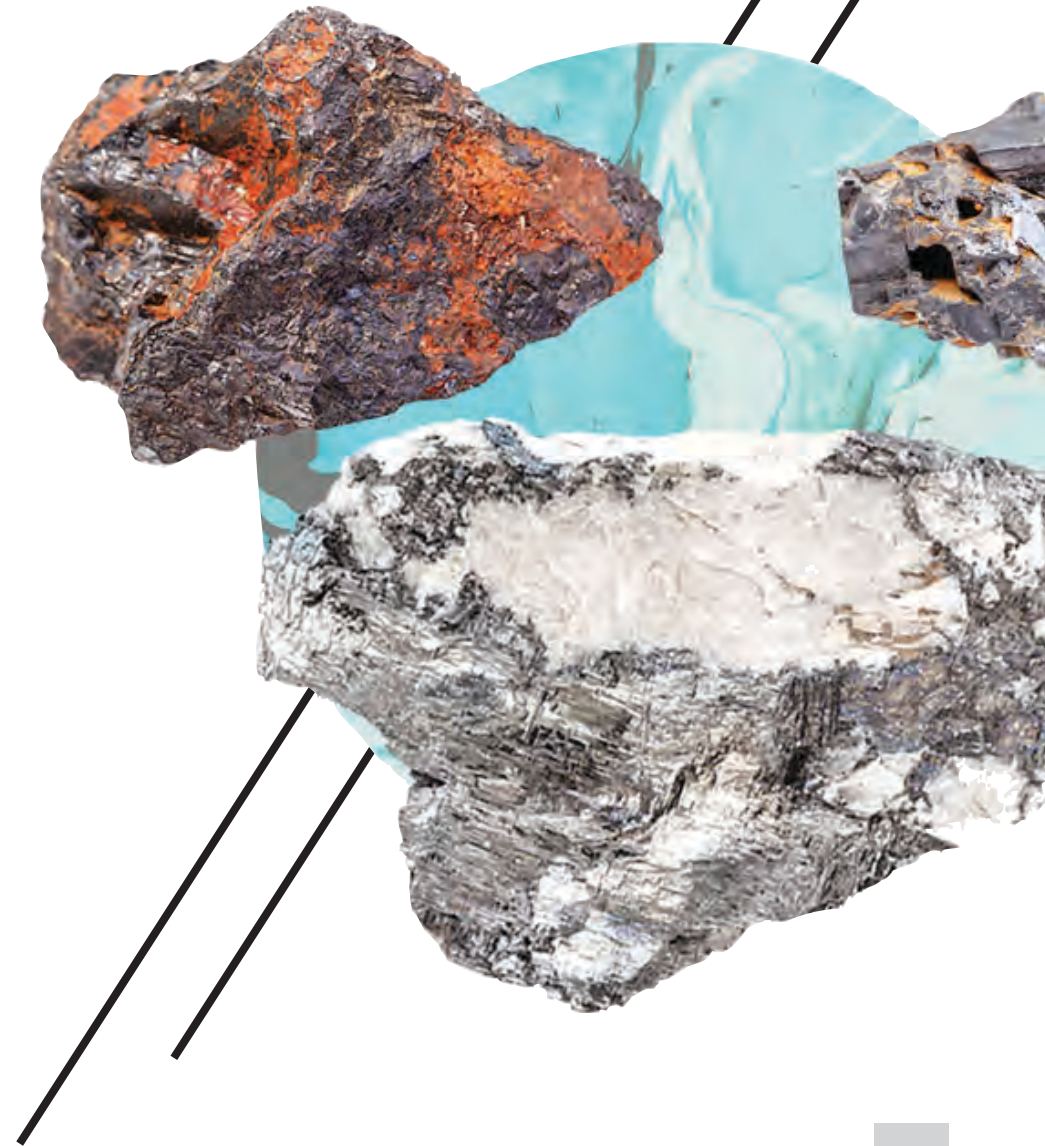

CHOOSE YOUR CORE MATERIAL



PROLITE

- **Weight:** 2850 gsm (0.25mm) 19% lighter than lead
- **Key Components:** Cerium and Plasticizers
- **Optimal kV Range:** 80-110kV
- **Certifications:** ASTM Certified

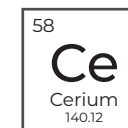

PREMIER

- **Weight:** 2600 gsm (0.25mm), 26% lighter than lead
- **Key Components:** Antimony and Plasticizers
- **Optimal kV Range:** 70-110kV
- **Certifications:** ASTM Certified

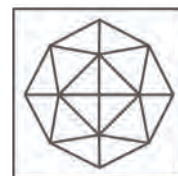
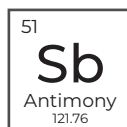

NANO

- **Weight:** 2300 gsm (0.25mm), 34% lighter than lead
- **Key Components:** Antimony and Plasticizers
- **Optimal kV Range:** 80-100kV
- **Certifications:** ASTM Certified

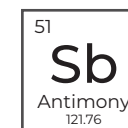



STANDARD LEAD

- **Weight:** 3500 gsm (0.25mm)
- **Key Components:** Lead and Plasticizers
- **Optimal kV Range:** 50-150kV
- **Certifications:** ASTM & IEC Certified

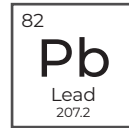

PROLITE BILAYER IEC

- **Weight:** 3000 gsm (0.25mm) 14% lighter than lead
- **Key Components:** Bismuth and Plasticizers
- **Optimal kV Range:** 60-150kV
- **Certifications:** ASTM & IEC Certified

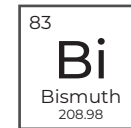

AVERAGE APRON WEIGHTS 0.50MM LE (LBS)

	STANDARD LEAD			PROLITE			PREMIER			NANO		
	Frontal	Vest & Skirt	Wraparound	Frontal	Vest & Skirt	Wraparound	Frontal	Vest & Skirt	Wraparound	Frontal	Vest & Skirt	Wraparound
X-Small	7.17	11.16	12.44	5.95	9.32	10.33	5.59	8.54	9.70	4.87	7.53	8.46
Small	7.68	12.74	14.40	6.37	10.64	11.95	5.99	9.75	11.23	5.22	8.60	9.79
Medium	8.63	14.75	15.95	7.16	12.32	13.23	6.73	11.29	12.44	5.87	9.96	10.84
Large	10.35	17.96	17.52	8.59	15.00	14.54	8.07	13.74	13.67	7.04	12.12	11.91
X-Large	11.74	19.56	19.08	9.74	16.33	15.84	9.16	14.96	14.89	7.98	13.20	12.98
2X-Large	12.28	21.46	22.00	10.20	17.92	18.26	9.58	16.42	17.16	8.35	14.48	14.96
3X-Large	14.21	23.84	-	11.79	19.91	-	11.08	18.24	-	9.66	16.09	-

Protech makes every effort to accurately record its apron weights. Because each category is averaged, the numbers we provide in the weight chart are subject to a +/- 15% weight variance. Minor length or width adjustments, including heavier fabrics, are not differentiated and instead, averaged together. Please consider this when referencing the weight chart. Weights are measured using a 0.50mm LE core material thickness.

APOLLO

QUICKSHIP APRONS

The Apollo Quickship line offers high quality, radiation safety apparel ready to ship within 24 hours. All Apollo aprons are made with our easy-to-clean, Satinguard antimicrobial fabrics on both the apron's exterior and interior. It also comes with a matching, velcro thyroid collar secured via buckle attachment.

Apollo Quickship aprons are available in the following standard sizes:

	Small	Medium	Large	XL
Height	5'4"	5'8"	5'11"	6'2"+
Chest	42"	45"	48"	53"
Waist	34	38	42	46
Hips	36	40	44	48
Front Length	34	37	40.5	42.5
Front Width	21	22	24	26
Vest Length	22	24	25	25
Skirt Length	20	20	21	21





READY TO SHIP IN 24 HOURS

Skip the lead times! Your Apollo apron will be ready to ship in as little as 24 hours.



ANTIMICROBIAL FABRICS

Apollo aprons are made from our premium, easy-to-clean, antimicrobial Satinguard performance fabric.



THYROID COLLAR INCLUDED

Because having a matching thyroid collar to go with your apron is almost as important as protecting your thyroid.

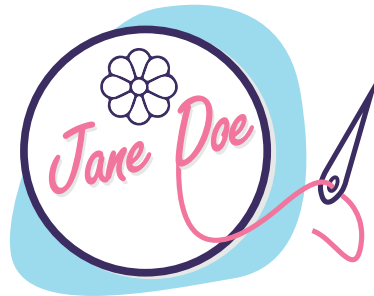

CUSTOM NAME TAG

Want to personalize your apron? A clear, vinyl sleeve on the apron shoulder holds an embroidered name tag.

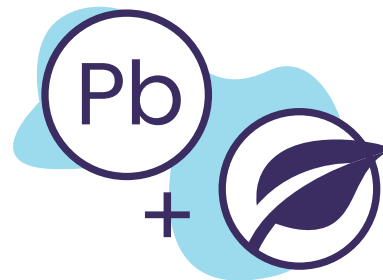

LEAD + LEAD FREE OPTIONS

Whether you need Light Lead or Lead Free core material, we've got you covered.



NO ORDER FORMS REQUIRED

No complicated paperwork here. Just more free time.

NOTE: To ensure you get your apron as quickly as possible, Apollo aprons are not available in "made-to-measure" sizing or other customizations (with the exception of a name tag).



FLEXBACK APRON

MODEL: APO-FB

0.50mm LE Protection in the Front
Lead, Velcro Thyroid collar included

Available in Prolite and Lead

Features: Elastic Back, Extra Shoulder Padding, Pocket

Sizes: S, M, L, XL, 2XL



VEST SKIRT APRON

MODEL: APO-VS

0.50mm LE Protection in the front
0.25mm LE Protection in the back

Lead, Velcro Thyroid collar included

Available in Prolite and Lead

Features: Buckle sets, Extra Shoulder Padding, Pocket

Sizes: S, M, L, XL



DENTAL APRON

MODEL: APO-DA

0.30mm LE Protection in the front

Thyroid collar included

Available in Lead

Features: Extra Shoulder Padding

Sizes: Adult (28" W x 31" L)



THYROID COLLAR

MODEL: APO-TCS

0.50mm LE Protection

Available in Velcro or Magnetic Closure

Available in Lead

Sizes: S, M, L, XL

#1 IN CUSTOM APRONS

Protech specializes in tailor-made aprons. You can choose from over 150 colors for your apron's exterior color, interior color, and binding. When you're finished, you can add embroidery, logos and other add-ons for a truly customized experience.

Hand-crafted and made with patented polymer technology, our Proguard Aprons are more light-weight, flexible and durable than the competition.

PROGUARD

PROGUARD

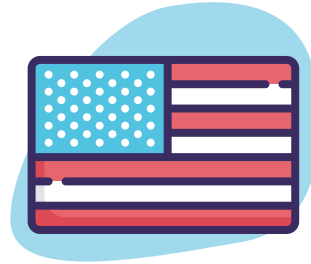

PROUDLY MADE IN THE USA

With full time quality control staff and ISO certification, you are getting the best in American made protective apparel.



IN-HOUSE EMBROIDERY & LOGOS

Don't let your apron "disappear." Our embroidery and logos are done in-house with modern monogram machines and the latest in digitization technology.

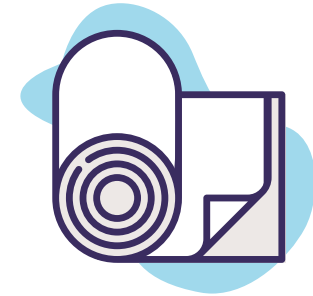

ULTRA-FLEXIBLE CORE MATERIALS

Proguard's Core materials feature more flexibility and durability which provides superior, long lasting comfort.



CUSTOM APRONS MADE TO MEASURE

Proguard aprons are made to order. More importantly, they can be highly customized according to size and various ergonomic needs by our highly trained staff.

CUSTOMIZATION OPTIONS



BACK STRAP

A Velcro backstrap keeps your apron shoulders secured and prevents slippage.



ELASTIC BACK

Provides enhanced adjustability and lumbar support by shifting apron weight from shoulders to the hips.



BACK MESH

Allows for maximum airflow in the back panels of your frontal apron and helps keep you cool.



NON-SLIP FABRIC

A high friction, anti-slip fabric that is added to the back interior of your skirt or other key areas depending on style selection which reduces slippage and improves fit.



CUSTOMIZATIONS: COMFORT OPTIONS

When it comes to designing your perfect custom apron, Protech is #1. Our great selection of apron add-ons can increase your protection and improve comfort. **We offer 3 types of apron customizations: Comfort, Protection and Design addons.** Each customization is clearly defined to ensure you make the right choices for yourself.



APRON SUSPENDERS

Need a little extra help holding up your skirt? Try our apron suspenders to keep that apron skirt right where you want it.



SURGICAL DROP SHOULDERS

Specialty velcro tabs can be added to different apron styles allowing for easy removal of your apron to maintain sterile field.



CUSTOMIZATIONS: DESIGN OPTIONS



LOGO AND EMBROIDERY

Personalize your apron by placing your name or logo anywhere! We also have stock logos to choose from. Common locations include the pocket, just above the pocket, and on your thyroid.

VELCRO PATCH

A velcro patch with custom embroidery can be added to a specific area on your apron. Typical locations are on the pocket, above pocket, or to the left of your pocket.



LUXRAY PATTERNS

Have your apron tailored to perfection with LuxRay's patterned accents on the apron sides, pocket and thyroid collar. If you have a special fabric you'd like to use, we can incorporate that as well!

EXTRA POCKETS

Need an extra pocket or two? Whether you need one on your skirt, inside your vest or even on your knees (yes, we did it), we can accommodate most requests. Shown here is a spacious L-shaped pocket which can be added to your skirt.



CUSTOMIZATIONS: PROTECTION OPTIONS



AXILLARY WINGS

Axillary wings are a protective flap sewn-in or “snapped-on” to your apron and offer vital protection to vulnerable breast tissue and red bone marrow areas. Protection levels will match your apron specifications.

SIDE EXTENSIONS

Side Extensions can provide an additional +2 inches of protection on both sides and provide important lateral protection. Protection levels will match your apron specifications.

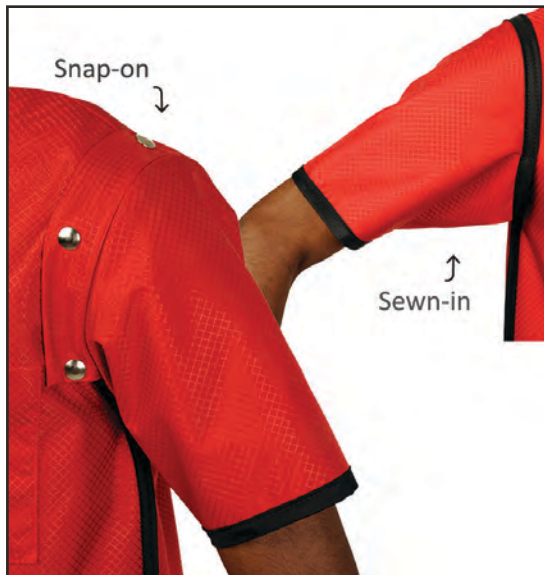

APRON SLEEVE

Apron sleeves wrap around your entire arm and offer comprehensive protection of vulnerable breast tissue and red bone marrow areas. Sleeves come standard in 0.25mm LE and can be sewn-in permanently or offered in our removable “Snap-on” option.

Note: To improve mobility, our apron sleeves are not sewn/attached at the armpit. For an upcharge, we can add a small “flap” which is tucked inside the apron armpit to ensure there are no gaps in protection.



APRON INSPIRATION

CUSTOM PROJECTS



LOUIS VUITTON MALE FLEXBACK APRON

One of our favorite custom apron projects was this LuxRay Flexback featuring Louis Vuitton accents. Custom from top to bottom, this apron boasted an attached thyroid collar and velcro-adjustable apron sleeve also made in the Louis Vuitton fabric.



LOUIS VUITTON FEMALE FLEXBACK APRON

Not to be outdone, we had another request for an exquisite Louis Vuitton apron.



If you have a special fabric you want to use, send it our way! Our team loves a challenge.



SWISS SOCCER CLUB SKIRT

This Swiss soccer club apron required great attention to detail to complete. The customer provided a special team flag to be utilized as the actual apron fabric.



THE DAWN OF JUSTICE APRONS

After custom flags and Louis Vuitton it was necessary that we honor the age of super heroes with our Special Edition DC Comics series. We hope Marvel and Avatar themes are next!



COMMITMENT ISSUES? TRY OUR

RENTAL APRONS

For those needing temporary radiation protection, Proguard rental aprons are the perfect solution. Rental aprons are essential for continuous education courses, cadaver workshops, or any other event that requires the use of fluoro and radiation protective apparel. There is no need to purchase and hold all of that inventory. Protech has a large selection of in stock apron rentals available to ship year round.

Frontal and Full protection styles available in sizes:

Small, Medium, Large, XL, 2XL.

FRONT PROTECTION

APRON FEATURES



Backstrap

Velcro backstrap securely fastens shoulder area.



Back Relief Belt

Wide, elastic belt provides lumbar support and maximum comfort.

Shoulder Padding

Premium foam padding in the shoulders provides extra comfort.

Apron Pocket

Belt Buckle Closure

ADDITIONAL CUSTOMIZATION OPTIONS

Thyroid Collar	Drop Shoulder	Wings
Extra Pocket	Embroidery	Back Mesh
Logo	Sleeve	

Core Material Weight (0.25mm) Thickness Options

Core Material	Weight (0.25mm)	Thickness Options
Lead	3500 gsm	0.25, 0.50mm
Prolite	2850 gsm	0.25, 0.35, 0.50mm
Prolite IEC	3000 gsm	0.25, 0.35, 0.50mm
Premier	2600 gsm	0.25, 0.35, 0.50mm
Nano	2300 gsm	0.35, 0.50mm



FOR SIZING AND COLOR OPTIONS SEE PAGES 68-79.



*CE applies to Lead and Prolite IEC from 0.25mm to 1.00mm.

BACK RELIEF APRON

MODEL: [AP-BR]

Save yourself from back pain with Protech's Back Relief apron. This apron features a unique padded belt system constructed with a bonded elasticized panel that will not lose its shape. When engaged, the special back relief belt provides lumbar support while transferring the weight of the apron from your shoulders to your hips for increased comfort and back support throughout the life of the apron. A velcro backstrap is also included to secure the apron around your shoulder area and prevent sliding.



BUCKLE APRON

MODEL: [AP-BA]

The Buckle Apron comes standard with an easy-release buckle allowing for quick removal of the apron. The belt is adjustable to accommodate different sizes. Criss-cross back straps provide a secure, comfortable fit.



FRONT PROTECTION

APRON FEATURES

Wide Body Back Panels
 The comfortable panels secure your apron and provides lumbar support.

Shoulder Padding
 Premium foam padding in the shoulders provides extra comfort.

Apron Pocket

Durable Buckle Closure

ADDITIONAL CUSTOMIZATION OPTIONS

Thyroid Collar	Drop Shoulder	Elastic Back
Extra Pocket	Embroidery	Backstrap
Logo	Sleeve	

Core Material Weight (0.25mm) Thickness Options

Core Material	Weight (0.25mm)	Thickness Options
Pb Lead	3500 gsm	0.25, 0.50mm
Prolite	2850 gsm	0.25, 0.35, 0.50mm
Prolite IEC	3000 gsm	0.25, 0.35, 0.50mm
Premier	2600 gsm	0.25, 0.35, 0.50mm
Nano	2300 gsm	0.35, 0.50mm



FOR SIZING AND COLOR OPTIONS SEE PAGES 68-79.



*CE applies to Lead and Prolite IEC from 0.25mm to 1.00mm.

FRONT PROTECTION



FLEXBACK APRON

MODEL: [AP-FB]

APRON FEATURES

+ Backstrap
Velcro backstrap securely fastens shoulder area.

+ Elastic Back
Provides enhanced adjustability and lumbar support. Shifts weight from shoulders & hips.

Shoulder Padding
Premium foam padding in the shoulders provides extra comfort.

Apron Pocket

Velcro Closure

ADDITIONAL CUSTOMIZATION OPTIONS

Thyroid Collar	Drop Shoulder	Wings
Extra Pocket	Embroidery	Back Mesh
Logo	Sleeve	

Core Material Weight (0.25mm) Thickness Options

Core Material	Weight (0.25mm)	Thickness Options
Pb Lead	3500 gsm	0.25, 0.50mm
Prolite	2850 gsm	0.25, 0.35, 0.50mm
Prolite IEC	3000 gsm	0.25, 0.35, 0.50mm
Premier	2600 gsm	0.25, 0.35, 0.50mm
Nano	2300 gsm	0.35, 0.50mm

Representing the gold standard of quality, the Flexback apron design provides enhanced back relief, comfort, and excellent weight distribution. Criss-cross back straps are specially designed with elastic to “flex” the apron’s weight burden off your shoulders to your hips, thereby providing support to your lower back. A velcro backstrap (shown below) is included and secures the apron around your shoulder area to prevent sliding.



FOR SIZING AND COLOR OPTIONS SEE PAGES 68-79.



*CE applies to Lead and Prolite IEC from 0.25mm to 1.00mm.

SURGICAL DROP APRON

MODEL: [AP-SD]

Maintain your sterile field with the quick release Surgical Drop Apron. Easy-release velcro closures allow the surgical drop to fall even when underneath your scrubs. With padded shoulders and a criss-cross back strap design the surgical drop apron provides maximum comfort for all users. Hanging straps are included to allow for easy storage on any Protech apron rack.



FRONT PROTECTION

APRON FEATURES

- +** **Hanging Straps**
Hanging straps on the shoulders allow for easy storage on any Protech apron rack.
- +** **Surgical Drop**
Quick release velcro closure tabs help maintain sterile field.
- Shoulder Padding**
Premium foam padding in the shoulders provides extra comfort.
- Apron Pocket**
- Velcro Closure**

ADDITIONAL CUSTOMIZATION OPTIONS

Thyroid Collar Extra Pocket Embroidery
Logo

Core Material	Weight (0.25mm)	Thickness Options
Pb Lead	3500 gsm	0.25, 0.50mm
P Prolite	2850 gsm	0.25, 0.35, 0.50mm
IEC Prolite IEC	3000 gsm	0.25, 0.35, 0.50mm
PR Premier	2600 gsm	0.25, 0.35, 0.50mm
N Nano	2300 gsm	0.35, 0.50mm



FOR SIZING AND COLOR OPTIONS SEE PAGES 68-79.



*CE applies to Lead and Prolite IEC from 0.25mm to 1.00mm.

FRONT PROTECTION

APRON FEATURES

Shoulder Padding
Premium foam padding in the shoulders provides extra comfort.

Apron Pocket

Tie Closure

ADDITIONAL CUSTOMIZATION OPTIONS

Thyroid Collar	Embroidery	Wings
Logo	Sleeve	Backstrap

Core Material	Weight (0.25mm)	Thickness Options
---------------	-----------------	-------------------

Core Material	Weight (0.25mm)	Thickness Options
Lead	3500 gsm	0.25, 0.50mm
Prolite	2850 gsm	0.25, 0.35, 0.50mm
Prolite IEC	3000 gsm	0.25, 0.35, 0.50mm
Premier	2600 gsm	0.25, 0.35, 0.50mm
Nano	2300 gsm	0.35, 0.50mm



FOR SIZING AND COLOR OPTIONS SEE PAGES 68-79.



*CE applies to Lead and Prolite IEC from 0.25mm to 1.00mm.

TIE APRON

MODEL: [AP-TA]

The Tie Apron is an easy-to-use, affordable option for x-ray protection. Utilizing a tie closure, the Apron's criss crossing straps ensure a secure and comfortable fit. See Pediatric options at the end of this section.



UROLOGY APRON

MODEL: [AP-UA]

If you sit while performing procedures requiring x-ray, you may be unnecessarily exposing yourself to radiation. The Urology Apron features a three panel system at the bottom of the apron which enables the user to sit comfortably while maintaining maximum coverage from x-ray.



FRONT PROTECTION

APRON FEATURES

+ **Multi-Panel Design**
Allows for easy maneuvering and a comfortable fit.

+ **Backstrap**
Velcro backstrap securely fastens shoulder area.

Shoulder Padding
Premium foam padding in the shoulders provides extra comfort.

Apron Pocket

Velcro Closure

ADDITIONAL CUSTOMIZATION OPTIONS

Thyroid Collar	Drop Shoulder	Wings
Extra Pocket	Embroidery	Back Mesh
Logo	Sleeve	

Core Material Weight (0.25mm) Thickness Options

Core Material	Weight (0.25mm)	Thickness Options
Pb Lead	3500 gsm	0.25, 0.50mm
P Prolite	2850 gsm	0.25, 0.35, 0.50mm
IEC Prolite IEC	3000 gsm	0.25, 0.35, 0.50mm
PR Premier	2600 gsm	0.25, 0.35, 0.50mm
N Nano	2300 gsm	0.35, 0.50mm



FOR SIZING AND COLOR OPTIONS SEE PAGES 68-79.



*CE applies to Lead and Prolite IEC from 0.25mm to 1.00mm.

FRONT PROTECTION

APRON FEATURES

+ **Wide Body Back Panels**
The comfortable panels secure your apron and provides lumbar support.

Shoulder Padding
Premium foam padding in the shoulders provides extra comfort.

Apron Pocket

Velcro Closure

ADDITIONAL CUSTOMIZATION OPTIONS

Thyroid Collar	Drop Shoulder	Wings	Backstrap
Extra Pocket	Embroidery	Back Mesh	
Logo	Sleeve		

Core Material	Weight (0.25mm)	Thickness Options
Pb Lead	3500 gsm	0.25, 0.50mm
P Prolite	2850 gsm	0.25, 0.35, 0.50mm
IEC Prolite IEC	3000 gsm	0.25, 0.35, 0.50mm
PR Premier	2600 gsm	0.25, 0.35, 0.50mm
N Nano	2300 gsm	0.35, 0.50mm



FOR SIZING AND COLOR OPTIONS SEE PAGES 68-79.



*CE applies to Lead and Prolite IEC from 0.25mm to 1.00mm.

VELCRO ADJUSTABLE APRON

MODEL: [AP-VA]

Do you need comfort and adjustability at an affordable price? The Velcro Adjustable apron has crisscrossing back straps that provide back support while securing the apron around your waist. Wide back straps prevent the apron from slipping around your shoulder and back area. Pediatric sizing available, see the end of the apron section.



MATERNITY APRON

MODEL: [AP-MA]

The maternity apron features easy ties and a quick release buckle to secure the back and front panels; allowing complete adjustability during pregnancy. The maternity apron also includes an additional .50mm equivalent half apron for a total of 1.00mm Pb protection over the abdominal area and lower extremities.



FULL PROTECTION

APRON FEATURES

- + Complete Coverage**
The front & back panels ensure you are fully protected from beginning to end of your pregnancy.
- + Half Apron Included**
A Half apron is included for additional protection as you progress through your pregnancy.
- + Tri-tab Closure**
Ensures a proper fit and easy donning.

Shoulder Padding
Premium foam padding in the shoulders provides extra comfort.



Apron Pocket

Tie & Buckle Closures

ADDITIONAL CUSTOMIZATION OPTIONS

Thyroid Collar	Wings	Extra Pocket
Embroidery	Logo	Sleeve

Core Material	Weight (0.25mm)	Thickness Options
---------------	-----------------	-------------------

 Prolite	2850 gsm	0.25, 0.35, 0.50mm
 Prolite IEC	3000 gsm	0.25, 0.35, 0.50mm
 Premier	2600 gsm	0.25, 0.35, 0.50mm



FOR SIZING AND COLOR OPTIONS SEE PAGES 68-79.



*CE applies to Lead and Prolite IEC from 0.25mm to 1.00mm.

FULL PROTECTION

APRON FEATURES

+ **Elastic Back**
Provides enhanced adjustability and lumbar support. Shifts weight from shoulders & hips.

+ **Single Front Panel**
Eliminates excess overlapping panels achieving a 15% weight reduction (compared to other wraparound and VS models).

+ **Tri-tab Closure**
Ensures a proper fit and easy donning.



Shoulder Padding
Premium foam padding in the shoulders provides extra comfort.

Apron Pocket

Velcro Closure

ADDITIONAL CUSTOMIZATION OPTIONS

Thyroid Collar Wings Extra Pocket
Embroidery Logo Sleeve

Core Material	Weight (0.25mm)	Thickness Options
 Prolite	2850 gsm	0.25, 0.35, 0.50mm
 Prolite IEC	3000 gsm	0.25, 0.35, 0.50mm
 Premier	2600 gsm	0.25, 0.35, 0.50mm



FOR SIZING AND COLOR OPTIONS SEE PAGES 68-79.



*CE applies to Lead and Prolite IEC from 0.25mm to 1.00mm.

WRAPAROUND FLEXBACK MATERNITY APRON

MODEL: [AP-WAFBMA]

The Wraparound Flexback Maternity apron combines the best qualities of our flexback apron with the full protection and back support of our wraparound back relief apron. The elastic stretch-back shifts weight from your shoulders to your hips while the tri-tab velcro closure system provides convenient, easy-on easy-off wearability. In addition, the 6" wide frontal velcro allows the wearer to adjust the crossties up or down to account for mom's growing belly. The Wrap Around Flexback eliminates excess overlapping lead and is up to **15% lighter than traditional wrap styles.**

Please note: For extra safety, Maternity Wraparound Flexback back panels come standard 0.25mm LE in each panel, creating enhanced 0.50mm LE protection at overlap.



WRAPAROUND FLEXBACK APRON



MODEL: [AP-WAFB]

Want the ultimate in comfort and protection? The Wrap Around Flexback apron combines the best qualities of our flexback apron with the full protection and back support of our wraparound back relief apron. The elastic stretch-back shifts weight from your shoulders to your hips while the tri-tab velcro closure system provides convenient, easy-on easy-off wearability. The Wrap Around Flexback eliminates excess overlapping lead and is up to **15% lighter than traditional wrap styles.**

Please note: Wraparound Flexback back panels come standard 0.125mm LE in each panel, creating 0.25mm LE protection at overlap. If greater protection is required, please specify.



FULL PROTECTION

APRON FEATURES

- ⊕ Elastic Back**
Provides enhanced adjustability and lumbar support. Shifts weight from shoulders & hips.
- ⊕ Single Front Panel**
Eliminates excess overlapping panels achieving a 15% weight reduction (compared to other wraparound and VS models).
- ⊕ Tri-tab Closure**
Ensures a proper fit.

- Shoulder Padding**
Premium foam padding in the shoulders provides extra comfort.
- Apron Pocket**
- Velcro Closure**

ADDITIONAL CUSTOMIZATION OPTIONS

- Thyroid Collar
- Extra Pocket
- Embroidery
- Logo

Core Material	Weight (0.25mm)	Thickness Options
Pb Lead	3500 gsm	0.25, 0.50mm
Prolite	2850 gsm	0.25, 0.35, 0.50mm
Prolite IEC	3000 gsm	0.25, 0.35, 0.50mm
Premier	2600 gsm	0.25, 0.35, 0.50mm
Nano	2300 gsm	0.35, 0.50mm



FOR SIZING AND COLOR OPTIONS SEE PAGES 68-79.



*CE applies to Lead and Prolite IEC from 0.25mm to 1.00mm.

FULL PROTECTION



TRI-TAB VEST AND SKIRT APRON

APRON FEATURES

- + Elastic Back**
Provides enhanced adjustability and lumbar support. Shifts weight from shoulders & hips.
- + Single Front Panel**
Eliminates excess overlapping panels achieving a 10% weight reduction (compared to VS model).
- + Tri-tab Closure Design**
Ensures a proper fit.
- + Non-slip Backing**
(On skirt interior) Reduces slippage and improves fit.

- Shoulder Padding**
Premium foam padding in the shoulders provides extra comfort.
- Apron Pocket**
- Multi-tab Velcro Closure**
- Hanging Tabs on Skirt**

ADDITIONAL CUSTOMIZATION OPTIONS

- Thyroid Collar
- Extra Pocket
- Suspenders (skirt)
- Embroidery
- Logo

Core Material	Weight (0.25mm)	Thickness Options
Lead	3500 gsm	0.25, 0.50mm
Prolite	2850 gsm	0.25, 0.35, 0.50mm
Prolite IEC	3000 gsm	0.25, 0.35, 0.50mm
Premier	2600 gsm	0.25, 0.35, 0.50mm
Nano	2300 gsm	0.35, 0.50mm



FOR SIZING AND COLOR OPTIONS SEE PAGES 68-79.



*CE applies to Lead and Prolite IEC from 0.25mm to 1.00mm.

MODEL: [AP-TVEST]_(vest only) [AP-SKIRT]_(skirt only) [AP-TVS]_(vest and skirt combo)

With an easy-on, easy-off multi tab (velcro) closure design, the Tri-tab is a popular style for vest and skirt combinations. Velcro closures are located on the left shoulder and around the hips. An elastic back allows for a flexible fit while providing premium comfort and back support. The Tri-tab Vest Skirt reduces excess overlapping lead and is **up to 10% lighter than traditional vest models**. **IMPORTANT: For the most accurate fit, please use the "Tri-tab Vest" measurements to determine your proper size.**

Please note: Tri-tab Vest back panels come standard 0.125mm LE in each panel, creating 0.25mm LE protection at overlap. If greater protection is required, please specify.



LEAD CONFIGURATION FOR PROGUARD

VS

ESSENTIAL

0.50MM LE LEAD CONFIGURATION EXAMPLE

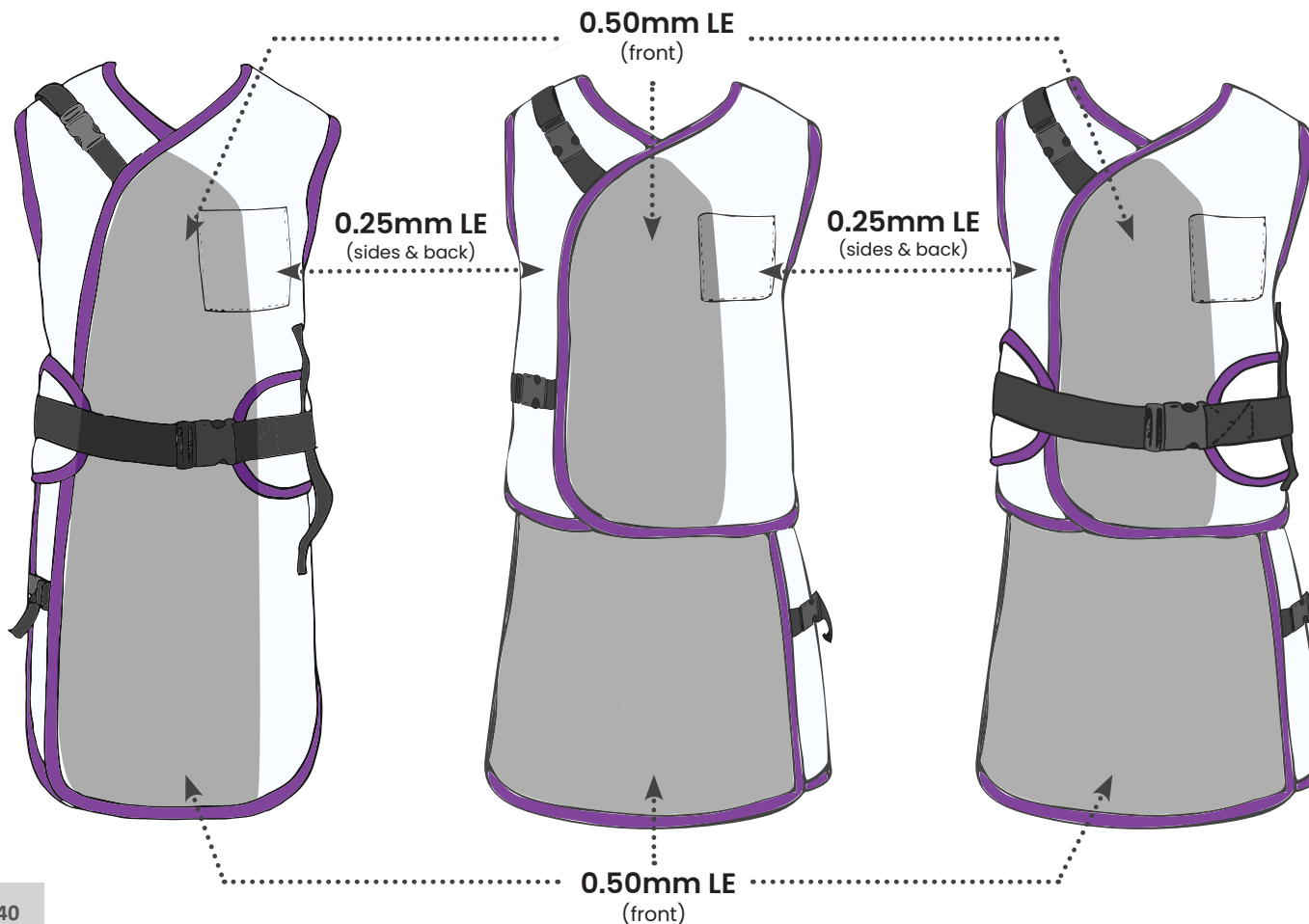

- 3/4 Overlapping Panel
- Desired protection at overlap where most sensitive organs are
 - helps with weight reduction
- Standard 0.25mm LE in back of skirt
- Standard Sizing Only

Dark gray areas indicate where vest panels overlap to create desired protection. In this example, two 0.25mm vest panels overlap to create 0.50mm LE protection over the body's most sensitive organs. White areas indicate 0.25mm protection.

LEAD CONFIGURATION FOR PROGUARD

BALANCE

0.35MM LE LEAD CONFIGURATION EXAMPLE

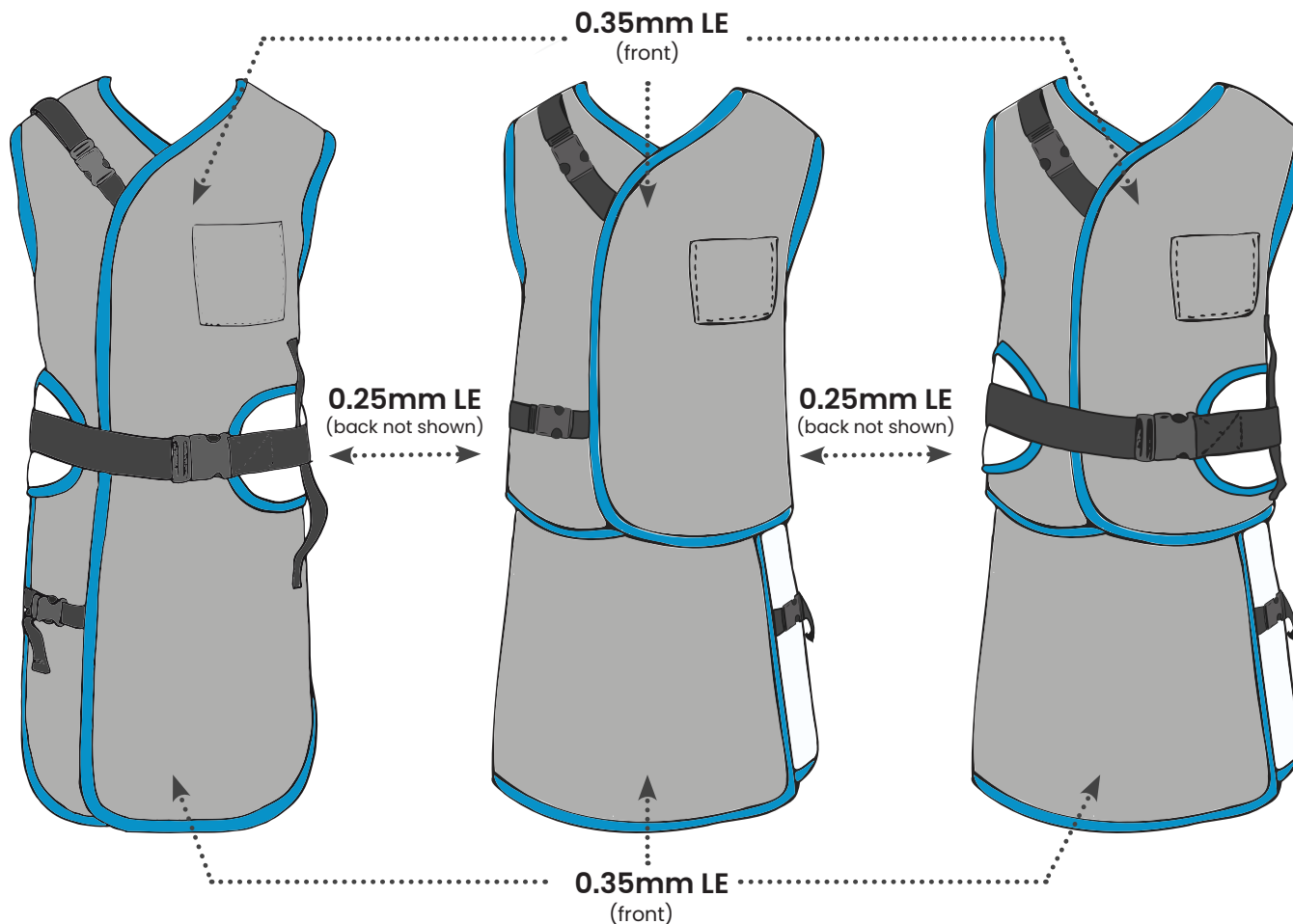

- Standard Overlapping Panel
- Seam-to-seam, single LE protection
- Standard 0.25mm LE in back (vest, skirt and wraparound)
- Custom and Standard Sizing available

Dark gray areas indicate where panel(s) are placed to create desired protection. In this example, there is uniform 0.35mm LE protection from seam to seam (no protection changes at overlap). This is achieved through the use of additional, internal layers of lead. White areas indicate 0.25mm protection.

ESSENTIAL™ WRAPAROUND BACK RELIEF APRON



MODEL: [AP-WAQ]

Offering full protection, this back relieving design transfers the weight from your shoulders to your hips with the aid of a 6" lumbar support belt. The Wrap Around Back Relief apron features velcro and buckle closures to ensure a proper fit. The Essential apron configuration **features extended front panels to achieve a 3/4 overlap (where protection is doubled) which allows for a lighter weight apron without compromising protection. The Essential Wraparound is available in standard sizing only.** For a made-to-measure Wraparound apron, see the Balance Wraparound on the next page.



FULL PROTECTION

APRON FEATURES

- Adjustable Buckle Set**
Adjustable buckle closures ensure a secure fit.
- Back Relief Belt**
Elastic lumbar support belt with buckle closure system.
- Extended Front Panels**
Front panels are extended to 3/4 overlap coverage where LE protection is doubled
- Shoulder Padding**
Premium foam padding in the shoulders provides extra comfort.
- Apron Pocket**
- Velcro and Buckle Closures**

ADDITIONAL CUSTOMIZATION OPTIONS

- Thyroid Collar
- Wings
- Extra Pocket
- Embroidery
- Logo
- Sleeve

Core Material Weight (0.25mm) Thickness Options

Core Material	Weight (0.25mm)	Thickness Options
Lead	3500 gsm	0.25, 0.50mm
Prolite	2850 gsm	0.25, 0.35, 0.50mm
Prolite IEC	3000 gsm	0.25, 0.35, 0.50mm
Premier	2600 gsm	0.25, 0.35, 0.50mm



FOR SIZING AND COLOR OPTIONS SEE PAGES 68-79.



*CE applies to Lead and Prolite IEC from 0.25mm to 1.00mm.

FULL PROTECTION

APRON FEATURES

- +** **Adjustable Buckle Set**
Adjustable buckle closures ensure a secure fit.
- +** **Back Relief Belt**
Elastic lumbar support belt with buckle closure system.
- +** **Seam-to-seam Protection**
Seam-to-seam, standardized protection in Front (no change in protection at overlap)

Shoulder Padding
Premium foam padding in the shoulders provides extra comfort.

Apron Pocket

Velcro and Buckle Closures

ADDITIONAL CUSTOMIZATION OPTIONS

Thyroid Collar Wings Extra Pocket
Embroidery Logo Sleeve

Core Material	Weight (0.25mm)	Thickness Options
Pb Lead	3500 gsm	0.25, 0.50mm
P Prolite	2850 gsm	0.25, 0.35, 0.50mm
IEC Prolite IEC	3000 gsm	0.25, 0.35, 0.50mm
PR Premier	2600 gsm	0.25, 0.35, 0.50mm
N Nano	2300 gsm	0.35, 0.50mm



FOR SIZING AND COLOR OPTIONS SEE PAGES 68-79.



*CE applies to Lead and Prolite IEC from 0.25mm to 1.00mm.

BALANCE™ WRAPAROUND BACK RELIEF APRON

MODEL: [AP-WABR]

Offering full protection, this back relieving design transfers the weight from your shoulders to your hips with the aid of a 6" lumbar support belt. The Wrap Around Back Relief apron features velcro and buckle closures to ensure a proper fit. The Balance configuration **features seam-to-seam, single LE protection with standard overlapping panels** (see below for lead configuration).



ESSENTIAL™ VEST AND SKIRT APRON

MODEL: [AP-VQ]_(vest only) [AP-SKIRT]_(skirt only) [AP-VSQ]_(vest and skirt combo)

Be prepared for prolonged procedures with the Vest Skirt apron. The two piece design shifts 70% of the weight directly to the hips, reducing back fatigue. The Essential apron configuration **features extended front panels to achieve a 3/4 overlap (where protection is doubled) which allows for a lighter weight apron without compromising protection.** The skirt comes standard with a premium non-slip fabric in the back. **Essential aprons are only available in standard sizes.** For a made-to-measure Vest Skirt, see the Balance Vest Skirt Apron.



FULL PROTECTION

APRON FEATURES

- +** **Adjustable Buckle Set**
Adjustable buckle closures ensure a secure fit.
- +** **Non-slip Backing**
(On skirt interior) Reduces slippage and improves fit.
- +** **Extended Front Panels**
Front panels are extended to 3/4 overlap coverage where LE protection is doubled
- Shoulder Padding**
Premium foam padding in the shoulders provides extra comfort.
- Apron Pocket**
- Velcro Closure**
- Hanging Tabs on Skirt**

ADDITIONAL CUSTOMIZATION OPTIONS

- Thyroid Collar
- Wings
- Extra Pocket
- Suspenders (skirt)
- Embroidery
- Logo
- Sleeve

Core Material	Weight (0.25mm)	Thickness Options
Pb Lead	3500 gsm	0.25, 0.50mm
P Prolite	2850 gsm	0.25, 0.35, 0.50mm
IEC Prolite IEC	3000 gsm	0.25, 0.35, 0.50mm
PR Premier	2600 gsm	0.25, 0.35, 0.50mm



FOR SIZING AND COLOR OPTIONS SEE PAGES 68-79.



*CE applies to Lead and Prolite IEC from 0.25mm to 1.00mm.

FULL PROTECTION



BALANCE™ VEST AND SKIRT APRON

APRON FEATURES

- +** **Adjustable Buckle Set**
Adjustable buckle closures ensure a secure fit.
- +** **Non-slip Backing**
(On skirt interior) Reduces slippage and improves fit.
- +** **Seam-to-seam Protection**
Seam-to-seam, standardized protection in Front (no change in protection at overlap)

- Shoulder Padding**
Premium foam padding in the shoulders provides extra comfort.
- Apron Pocket**
- Velcro Closure**
- Hanging Tabs on Skirt**

ADDITIONAL CUSTOMIZATION OPTIONS

Thyroid Collar Wings Extra Pocket Suspenders (skirt)
Embroidery Logo Sleeve

Core Material	Weight (0.25mm)	Thickness Options
Pb Lead	3500 gsm	0.25, 0.50mm
P Prolite	2850 gsm	0.25, 0.35, 0.50mm
IEC Prolite IEC	3000 gsm	0.25, 0.35, 0.50mm
PR Premier	2600 gsm	0.25, 0.35, 0.50mm
N Nano	2300 gsm	0.35, 0.50mm

MODEL: [AP-V]_(vest only) [AP-SKIRT]_(skirt only) [AP-VS]_(vest and skirt combo)

Be prepared for prolonged procedures with the Vest Skirt apron. The two piece design shifts 70% of the weight directly to the hips, reducing back fatigue. The Balance configuration **features seam-to-seam, single LE protection with standard overlapping panels** (see pages 34-35 for lead configuration information). The skirt comes standard with a premium non-slip fabric in the back.



FOR SIZING AND COLOR OPTIONS SEE PAGES 68-79.



*CE applies to Lead and Prolite IEC from 0.25mm to 1.00mm.

ESSENTIAL™ FLEXBACK VEST AND SKIRT APRON



MODEL: [AP-VFBQ]_(vest only) [AP-SKIRT]_(skirt only) [AP-VSFBQ]_(vest and skirt combo)

The Essential Vest Skirt Flexback shifts 70% of the weight directly to the hips with added support of an adjustable, elastic back relief belt. The Essential apron configuration **features extended front panels to achieve a 3/4 overlap (where protection is doubled) which allows for a lighter weight apron without compromising protection.** The skirt comes standard with an anti-slip fabric in the back (interior) to keep your skirt in place. **Essential aprons are only available in standard sizes.** For a made-to-measure Vest Skirt Flexback, see the Balance Vest Skirt Flexback Apron.



FULL PROTECTION

APRON FEATURES

- + **Adjustable Buckle Set**
Adjustable buckle closures ensure a secure fit.
- + **Flexback Belt**
Wraps internally around your back and securely fastens in the front.
- + **Non-slip Backing**
(On skirt interior) Reduces slippage and improves fit.
- + **Extended Front Panels**
Front panels are extended to 3/4 overlap coverage where LE protection is doubled
- Shoulder Padding**
Premium foam padding in the shoulders provides extra comfort.
- Apron Pocket**
- Velcro Closure**
- Hanging Tabs on Skirt**

ADDITIONAL CUSTOMIZATION OPTIONS

Thyroid Collar Wings Extra Pocket Suspenders (skirt)
Embroidery Logo Sleeve

Core Material Weight (0.25mm) Thickness Options

Pb	Lead	3500 gsm	0.25, 0.50mm
Prolite	Prolite	2850 gsm	0.25, 0.35, 0.50mm
Prolite IEC	Prolite IEC	3000 gsm	0.25, 0.35, 0.50mm
PR	Premier	2600 gsm	0.25, 0.35, 0.50mm



FOR SIZING AND COLOR OPTIONS SEE PAGES 68-79.



*CE applies to Lead and Prolite IEC from 0.25mm to 1.00mm.

FULL PROTECTION



BALANCE™ FLEXBACK VEST AND SKIRT APRON

MODEL: [AP-VFB]_(vest only) [AP-SKIRT]_(skirt only) [AP-VSFB]_(vest and skirt combo)

APRON FEATURES

- ⊕ Adjustable Buckle Set**
Adjustable buckle closures ensure a secure fit.
- ⊕ Flexback Belt**
Wraps internally around your back and securely fastens in the front.
- ⊕ Non-slip Backing**
(On skirt interior) Reduces slippage and improves fit.
- ⊕ Seam-to-seam Protection**
Seam-to-seam, standardized protection in Front (no change in protection at overlap)
- Shoulder Padding**
Premium foam padding in the shoulders provides extra comfort.
- Apron Pocket**
- Velcro Closure**
- Hanging Tabs on Skirt**

ADDITIONAL CUSTOMIZATION OPTIONS

Thyroid Collar Wings Extra Pocket Suspenders (skirt)
Embroidery Logo Sleeve

Core Material	Weight (0.25mm)	Thickness Options
Lead	3500 gsm	0.25, 0.50mm
Prolite	2850 gsm	0.25, 0.35, 0.50mm
Prolite IEC	3000 gsm	0.25, 0.35, 0.50mm
Premier	2600 gsm	0.25, 0.35, 0.50mm
Nano	2300 gsm	0.35, 0.50mm

The Vest Skirt Flexback shifts 70% of the weight directly to the hips with added support of an adjustable, elastic back relief belt. The Balance configuration **features seam-to-seam, single LE protection with standard overlapping panels** (see below for lead configuration). The skirt comes standard with an anti-slip fabric in the back (interior) to keep your skirt in place.



FOR SIZING AND COLOR OPTIONS SEE PAGES 68-79.



*CE applies to Lead and Prolite IEC from 0.25mm to 1.00mm.



DENTAL PANORAMIC PONCHO

MODEL	AP-DP
CORE MATERIALS	All Core Types (see pages 14-15)
THICKNESS	0.50, 0.35, 0.25mm (standard) LE
CLOSURE	Velcro
SIZING	Adult: 24" W x 27" L (front) 16" L (back) Pediatric: 18"W x 22"L (front) 12"L (back)
CUSTOMIZATIONS	Embroidery and Logo
ADD-ONS	Thyroid Collar
COLORS	See fabric colors on pages 73-79
CE	Yes

Drapes over the body to provide front and back protection. Similar to the dental cape but the velcro closure is on the shoulder area. The Dental Panoramic Poncho comes in two sizes.



DENTAL APRON

MODEL	AP-DA
CORE MATERIALS	Lead - 0.25mm
AND THICKNESSES	Prolite - 0.30mm Prolite Bilayer IEC - 0.30mm
CLOSURE	None
SIZING	Adult: 28" W x 23.5" L (from neckline) Pediatric: 23.5" W x 18" L (from neckline)
CUSTOMIZATIONS	Embroidery and Logo
ADD-ONS	Thyroid Collar, Anti-slip fabric
COLORS	See fabric colors on pages 73-79
CE	Yes

The Dental apron provides optimal protection during dental procedures and x-rays. Available in both lead and lead-free options, the dental apron comes with large hanging straps for easy storage. Optional upgrades like thyroid collar and anti-slip interior are also available.

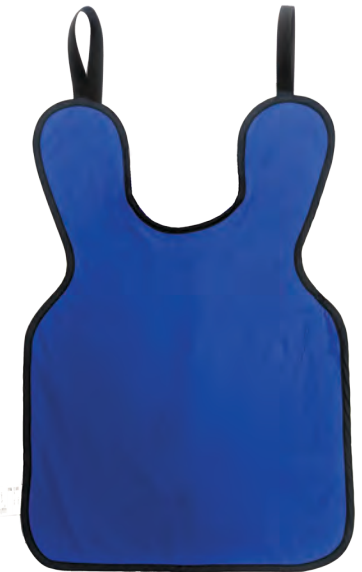

ORIGINAL THYROID COLLAR



MODEL	AP-TCO
CORE MATERIALS	All Core Types (see pages 14-15)
THICKNESS	0.50 (standard), 0.35, 0.25mm LE
CLOSURE	Velcro (shown), Magnets or Buckle
SIZING	Small: 13-14" (neck circ.) Medium: 15-16" (neck circ.) Large: 17"+ (neck circ.) X-Large: Custom (neck circ.)
CUSTOMIZATIONS	Embroidery and Logo
ATTACHMENTS	Loose, Clip, Keyring, Tethered
COLORS	See fabric colors on pages 73-79
CE	Yes

The original style thyroid collar fits lower on the neck, offering coverage of the thyroid against scatter radiation. Velcro strips on the end allow for neck size adjustability. This streamlined style is our most popular.



BIB THYROID COLLAR



MODEL	AP-TCB (reg.) / AP-TCBL (oversized)
CORE MATERIALS	All Core Types (see pages 14-15)
THICKNESS	0.50 (standard), 0.35, 0.25mm LE
CLOSURE	Velcro (shown) or Magnets
SIZING	One size fits all
DIMENSIONS	Regular - 24" L x 7.5" H (4.5" bib) Oversized - 24" L x 9" H (6" Bib)
CUSTOMIZATIONS	Embroidery and Logo
ATTACHMENTS	Loose, Clip, Keyring, Tethered
COLORS	See fabric colors on pages 73-79
CE	No

The Bib thyroid's streamlined design provides a comfortable fit as well as complete coverage to the neck area. For those wanting a little extra coverage, we also offer an oversized Bib option (6" in length).





PROGUARD THYROID COLLAR

MODEL	AP-TCG
CORE MATERIALS	All Core Types (see pages 14-15)
THICKNESS	0.50 (standard), 0.35, 0.25mm LE
CLOSURE	Velcro
SIZING	Small: 21" (neck circ.) Medium: 22" (neck circ.) Large: 23" (neck circ.) X-Large: 24" (neck circ.)
CUSTOMIZATIONS	Embroidery and Logo
ATTACHMENTS	Loose, Clip, Keyring, Tethered
COLORS	See fabric colors on pages 73-79
CE	Yes

Featuring a form-fitting design and velcro closure, the Proguard thyroid collar provides front and back protection.



VISOR THYROID COLLAR

MODEL	AP-TCV
CORE MATERIALS	All Core Types (see pages 14-15)
THICKNESS	0.50 (standard), 0.35, 0.25mm LE
CLOSURE	Velcro (shown) or Magnets
SIZING	Small: 25" (neck circ.) Large: 27" (neck circ.)
CUSTOMIZATIONS	Embroidery and Logo
ATTACHMENTS	Loose, Clip, Keyring, Tethered
COLORS	See fabric colors on pages 73-79
CE	No

Ergonomically designed for a snug fit, the Visor thyroid is optimized for comfort and maximum protection. The neck piece provides additional front and lateral protection.



STANDARD THYROID COLLAR



MODEL	AP-TCS
CORE MATERIALS	All Core Types (see pages 14-15)
THICKNESS	0.50 (standard), 0.35, 0.25mm LE
CLOSURE	Velcro, Magnets or Buckle (shown)
SIZING	Small: 13-14" (neck circ.) Medium: 15-16" (neck circ.) Large: 17"+ (neck circ.) X-Large: Custom
CUSTOMIZATIONS	Embroidery and Logo
ATTACHMENTS	Loose, Clip, Keyring, Tethered
COLORS	See fabric colors on pages 73-79
CE	Yes

The standard radiation thyroid collar is designed to fit higher along the neck while providing complete coverage of the thyroid against x-ray radiation.



MAMMOGRAPHY THYROID COLLAR



MODEL	AP-TCM
CORE MATERIALS	All Core Types (see pages 14-15)
THICKNESS	0.50 (standard), 0.35, 0.25mm LE
CLOSURE	Velcro (shown) or Buckle
SIZING	One Size: 29" L, 4" Bib
CUSTOMIZATIONS	Embroidery and Logo
ATTACHMENTS	Loose, Clip, Keyring, Tethered
COLORS	See fabric colors on pages 73-79
CE	Yes

Don't let the standard or original thyroid collar get all the attention. The mammography's sleek profile provides a detachable alternative to "sewn-in" thyroid collars while allowing for adjustability. Additionally, the mammography thyroid collar serves as a valuable option for patient protection.



THYROID COLLAR COVERS

MODEL	SG-TCCD
CORE MATERIALS	None
MATERIAL	Blue SMS
SIZING	One size fits all
FEATURES	Disposable
UOM QTY	50 per box

Our disposable thyroid collar covers do not provide protection against x-ray, but are a useful way to encourage the use of thyroid collars by keeping them clean. The thyroid collar covers fit a wide variety of thyroid collar styles, will prevent damage from make-up and prevent the build-up of filth. Extend the life of your thyroid collars by covering them with ScatterGuard's hygienic, disposable thyroid collar cover.



DISPOSABLE THYROID COLLAR



MODEL	SG-DTHY
CORE MATERIALS	Prolite
THICKNESS	0.125, 0.25*, or 0.50mm LE
CLOSURE	Velcro
SIZING	Regular: 13-16" (neck circ.) Large: 17-20" (neck circ.)
CUSTOMIZATIONS	None
FABRIC	ActiV
CE	Yes* (only 0.25mm LE)

ScatterGuard's disposable Thyroid Collars are designed to provide essential protection against scatter radiation. Light-weight and available in 2 sizes, our disposable thyroid collar is made with a premium lead-free material and may be disposed of through normal waste procedures. The disposable Thyroid Collar blocks up to 95% of radiation.



DISPOSABLE SMART CAP



MODEL	SG-DCAP
CORE MATERIALS	Prolite
THICKNESS	0.60, 0.125, 0.25*, or 0.50mm LE
CLOSURE	Ties
SIZING	Small - 21" (head circ.)
	Medium - 22" (head circ.)
	Large - 23" (head circ.)
CUSTOMIZATIONS	None
FABRIC	Blue SMS
CE	Yes* (only 0.25mm LE)

ScatterGuard's disposable Smart Caps are designed to provide essential protection against scatter radiation. Smart Caps feature a cotton inner-liner to absorb perspiration and ensure a comfortable fit. Light-weight and adjustable, our Smart Cap is available in 3 sizes. The Cap is made with a premium lead-free material and may be disposed of through normal waste procedures. The disposable Smart Cap blocks up to 95% of radiation.

Cotton
Inner-liner



PROGUARD SMART CAP



MODEL	AP-PGCAP
CORE MATERIALS	All Core Types (see pages 14-15)
THICKNESS	0.50 (standard), 0.35, 0.25mm LE
CLOSURE	Beaded Adjustable Strap
SIZING	SM-M: 21-22" (head circ.) L-XL: 23-25" (head circ.)
CUSTOMIZATIONS	Embroidery and Logo
COLORS	See fabric colors on pages 73-79
CE	Yes

Need head protection that is breathable, light-weight, and comfortable? The Proguard Smart Cap features breathable CoolGuard spandex fabric on the top while providing protection around the sides of your head.



PAGE CAP



MODEL	AP-PAGE
CORE MATERIALS	All Core Types (see pages 14-15)
THICKNESS	0.50 (standard), 0.35, 0.25mm LE
CLOSURE	Velcro
SIZING	Small: 21" (head circ.) Medium: 22" (head circ.) Large: 23" (head circ.) X-Large: 24" (head circ.)
CUSTOMIZATIONS	Embroidery and Logo
PROTECTION	Side Protection
COLORS	See fabric colors on pages 73-79
CE	Yes

The Page Cap is designed to provide protection around the sides of your head, while the top contains no lead. Alternatively, similar to a scrub cap, the Head Cap provides x-ray protection around the entire head. Velcro tab closures allow for an adjustable fit on both styles. *Sizes based on head circumference.



HEAD CAP



MODEL	AP-CAP
CORE MATERIALS	All Core Types (see pages 14-15)
THICKNESS	0.50 (standard), 0.35, 0.25mm LE
CLOSURE	Velcro
SIZING	Small: 21" (head circ.) Medium: 22" (head circ.) Large: 23" (head circ.) X-Large: 24" (head circ.)
CUSTOMIZATIONS	None
PROTECTION	Top and Side Protection
COLORS	See fabric colors on pages 73-79
CE	Yes

Similar to a scrub cap, the Head Cap provides x-ray protection around the entire head. Velcro tab closures allow for an adjustable fit on both styles. *Sizes based on head circumference.



SCOLIOSIS STOLE



MODEL	AP-STOLE
CORE MATERIALS	All Core Types (see pages 14-15)
THICKNESS	0.50 (standard), 0.35, 0.25mm LE
CLOSURE	Buckle
SIZING	Pediatric: 15" x 4.75" Medium: 18.5" x 6.75" Large: 23.5" x 8"
CUSTOMIZATIONS	Embroidery and Logo
COLORS	See fabric colors on pages 73-79
CE	Yes

The scoliosis stole is primarily used for spinal imaging. The shield features velcro panels and an adjustable belt for proper positioning. The neck area does not contain lead, allowing complete visibility of the spine during x-ray, while offering protection to the breast area. This shield is great for scoliosis studies.



GONAD/OVARIAN SHIELD



MODEL	AP-GONAD/GONAD-SET
CORE MATERIALS	All Core Types (see pages 14-15)
THICKNESS	0.50 (standard), 0.35, 0.25mm LE
CLOSURE	Velcro (standard) or Buckle
SIZING	Small - 5.75" x 4.5" Medium - 7.6" x 6.4" Large - 9.5" x 7.8" Pediatric sizing available (pg 68)
CUSTOMIZATIONS	Embroidery and Logo
SPECIAL	Available as a set of 3 or individually
COLORS	See fabric colors on pages 73-79
CE	Yes

This unique gonad/ovarian shield belt system comes complete with four interchangeable sizes which provide coverage from x-ray for a variety of needs. The adjustable Velcro or buckle also allows the user to fit almost any waist size. The gonad/ovarian belt system comes as a set of 3 sizes (adult or pediatric sets). They can also be purchased individually.



APRON SLEEVE



MODEL	AP-SLV (sewn-in) / SLV2 (snap-on)
CORE MATERIALS	All Core Types (see pages 14-15)
THICKNESS	0.50, 0.35, 0.25mm (standard) LE
CLOSURE	Snap-on or Sewn-in
SIZING (FEMALE)	Small, Medium, Large, XL, 2XL
SIZING (MALE)	Small, Medium, Large, XL, 2XL Length (reg.): 11" Length (short): 8.5" Circumference: see size charts
CUSTOMIZATIONS	Embroidery and Logo
COLORS	See fabric colors on pages 73-79
CE	Yes

This optional sleeve is available for many apron styles and protects the upper arm and shoulder from direct beam and scatter radiation. It can be attached as a snap-on or directly sewn-on. Please note that the apron sleeve is not fully attached at the armpit. An optional protection/coverage for additional protection/coverage (see customizations page for more info). Price is per (1) sleeve.



SHIN GUARDS



MODEL	AP-SG
CORE MATERIALS	All Core Types (see pages 14-15)
THICKNESS	0.50 (standard), 0.35, 0.25mm LE
CLOSURE	Velcro
SIZING	SM: 13" x 9" M: 14" x 10" L: 16" x 12" XL: 18" x 24"
CUSTOMIZATIONS	Embroidery and Logo
COLORS	See fabric colors on pages 73-79
CE	Yes

When being exposed to ionizing radiation, all forms of radiation protection are necessary. Shin Guards protect against beam scatter when no table drapes are present. Optional foot covers may be added (AP-FOOT).



(AP-FOOT)

HALF APRON



MODEL	AP-HA
CORE MATERIALS	All Core Types (see pages 14-15)
THICKNESS	0.50 (standard), 0.35, 0.25mm LE
CLOSURE	Velcro
SIZING	SM (pediatric): 10" x 10" MD: 18" x 16" LG: 24" x 20" XL: 24" x 24"
CUSTOMIZATIONS	Embroidery and Logo
COLORS	See fabric colors on pages 73-79

The half apron can provide extra radiation protection. Selling it separate also allows you to mix and match a smaller bottom half with a larger top piece or vice versa.



CORSET BELT

MODEL	AP-CORSET
PROTECTION	None
SIZING (FEMALE)	Small - 4XL (Use apron waist measurement)
SIZING (MALE)	XS - XL (Use apron waist measurement)
COLORS	Black

Our corset belt is a great apron accessory for added back support when wearing a radiation protective apron. The finger pull tab and pulley system along the spine provides for simple adjustment and even tension.

***The corset belt is worn under the apron.**
****Use apron waist measurements on page 59 to determine your size.**



BACK RELIEF BELT

MODEL	AP-BLT
PROTECTION	None
CLOSURE	Buckle
SIZING (FEMALE)	XS: 24-26" S: 26-28" M: 28-31" L: 31-33" XL: 34-38"
SIZING (MALE)	XS: 30-33" S: 33-36" M: 37-40" L: 41-44" XL: 44-48"
CUSTOMIZATIONS	None
COLORS	See fabric colors on pages 73-79

The back relief belt is constructed of neoprene bonded elastic. It features high quality components that do not lose elasticity. The belt also features a non-slip adjustable buckle to ensure a secure fit. The back relief belt attaches separately from the apron.



PEDIATRIC PROTECTION



PEDIATRIC TIE APRON



MODEL	AP-TA-CH
CORE MATERIALS	All Core Types (see pages 14-15)
THICKNESS	0.50 (standard), 0.35, 0.25mm LE
CLOSURE	Tie
SIZING	Small: 12 x 24" (Ages 1-3) Medium: 14 x 26" (Ages 4-6) Large: 16 x 28" (Ages 7-10)
CUSTOMIZATIONS	Embroidery and Logo
COLORS	See fabric colors on pages 73-79
CE	Yes

The Tie Apron is an easy-to-use, affordable option for x-ray protection. Utilizing a tie closure, the Tie Apron's criss crossing straps ensure a secure and comfortable fit. Premium foam padding in the shoulders provides extra comfort.



PEDIATRIC VELCRO ADJUSTABLE APRON



MODEL	AP-VA-CH
CORE MATERIALS	All Core Types (see pages 14-15)
THICKNESS	0.50 (standard), 0.35, 0.25mm LE
CLOSURE	Velcro
SIZING	Small: 12 x 24" (Ages 1-3) Medium: 14 x 26" (Ages 4-6) Large: 16 x 28" (Ages 7-10)
CUSTOMIZATIONS	Embroidery and Logo
COLORS	See fabric colors on pages 73-79
CE	Yes

The Velcro Adjustable apron has crisscrossing back straps that provide back support while securing the apron around your waist. Wide back straps prevent the apron from slipping around your shoulder and back area.



PEDIATRIC HALF APRON



MODEL	AP-HA-CH
CORE MATERIALS	All Core Types (see pages 14-15)
THICKNESS	0.50 (standard), 0.35, 0.25mm LE
CLOSURE	Velcro
SIZING	Pediatric: 10" x 10"
CUSTOMIZATIONS	Embroidery and Logo
COLORS	See fabric colors on pages 73-79
CE	Yes

The half apron can provide extra radiation protection. Selling it separate also allows you to mix and match a smaller bottom half with a larger top piece or vice versa.



PEDIATRIC DENTAL APRON



MODEL	AP-DA-CH
CORE MATERIALS	Lead - 0.25mm
& THICKNESS	Prolite - 0.30mm
	Prolite Bilayer IEC - 0.30mm
CLOSURE	None
SIZING	Pediatric: 23.5" W x 18" L (from neckline)
CUSTOMIZATIONS	Embroidery and Logo
ADD-ONS	Thyroid Collar, Anti-slip Fabric
COLORS	See fabric colors on pages 73-79
CE	Yes

The Dental apron provides optimal protection during dental procedures and x-rays. Available in both lead and lead-free options, the dental apron comes with large hanging straps for easy storage. Optional upgrades like thyroid collar and anti-slip interior are also available.





PEDIATRIC THYROID COLLAR

MODEL	AP-TCO-PD
CORE MATERIALS	All Core Types (see pages 14-15)
THICKNESS	0.50 (standard), 0.35, 0.25mm LE
CLOSURE	Velcro
SIZING	Infant: Custom (Ages 0-1) Pediatric: 10" (Ages 2-8)
CUSTOMIZATIONS	Embroidery and Logo
ATTACHMENTS	Loose, Clip, Keyring, Tethered
COLORS	See fabric colors on pages 73-79
CE	Yes

Our Pediatric Thyroid collar is based on the original style and is designed to protect children ages 2 to 8 from harmful x-ray. For ages 9 and up, simply opt for a small thyroid collar (12" neck circumference).



PEDIATRIC GONAD SHIELD SET

MODEL	AP-GONADSET2
CORE MATERIALS	All Core Types (see pages 14-15)
THICKNESS	0.50 (standard), 0.35, 0.25mm LE
CLOSURE	Velcro (standard) or Buckle
SIZING	1 Pediatric: 3.75" x 3.75" 1 Child: 5" x 4" 1 Small: 5.75" x 4.5"
CUSTOMIZATIONS	Embroidery and Logo
COLORS	See fabric colors on pages 73-79
CE	Yes

This unique pediatric gonad/ovarian shield belt system comes complete with three interchangeable sizes which provide coverage from x-ray for a variety of needs. The adjustable Velcro or optional buckle (shown) also allows the user to fit almost any waist size. The gonad/ovarian belt system comes as a set of 3 sizes, or can be purchased individually.



PEDIATRIC SCOLIOSIS STOLE



MODEL	AP-STOLE-CH
CORE MATERIALS	All Core Types (see pages 14-15)
THICKNESS	0.50 (standard), 0.35, 0.25mm LE
CLOSURE	Buckle
SIZING	Pediatric: 15" x 4.75"
CUSTOMIZATIONS	Embroidery and Logo
COLORS	See fabric colors on pages 73-79
CE	Yes

The scoliosis stole is primarily used for spinal imaging. The shield features velcro panels and an adjustable belt for proper positioning. The neck area does not contain lead, allowing complete visibility of the spine during x-ray, while offering protection to the breast area. This shield is great for scoliosis studies.



TUGGA BABY



MODEL	RE-BABY
FRAME TYPE	Goggles
FRONT LENS	0.75mm Pb Glass
WEIGHT	42g
FRAME SIZE	46-18
MATERIAL	N/A
SIDE SHIELDS	N/A
RX OPTIONS	N/A
MIN PRG PD	N/A
CE	Yes
COLORS	Shiny Pink, Shiny Blue, Shiny Green

Protech's Tugga Baby pediatric glasses provide essential protection during medical fluoroscopy and feature a universal fit with its adjustable headband.



APRON STORAGE

EXTEND THE LIFE OF YOUR APRON

When not in use, garments should be placed on a hanger or stored using Protech's apron storage equipment. Avoid contact with hot surfaces or exposure to direct sunlight. Also avoid contact with sharp objects, as these may damage the garment's protective core material. For transportation, garments should be carefully rolled up, not folded, and placed into a box or Protech duffle bag.

APRON DUFFLE BAG

MODEL: [AS-DUFFLE]

CAPACITY: UP TO 2 APRONS

Our duffle bag protects your aprons while traveling between facilities or out of the country. Protect and store your aprons for transport now with our affordable, high quality duffle bag. Features: 10" Velcro Opening, Carrying Handle & Shoulder Strap.

For all color options, refer to pages 73-79.



APRON HANGER

MODEL: [AS-HANGER]

CAPACITY: 40LBS

Constructed out of aluminum for durability and longevity this apron hanger is used for the storage of radiation protection aprons. It features hook style ends that are designed to hold lead skirts.

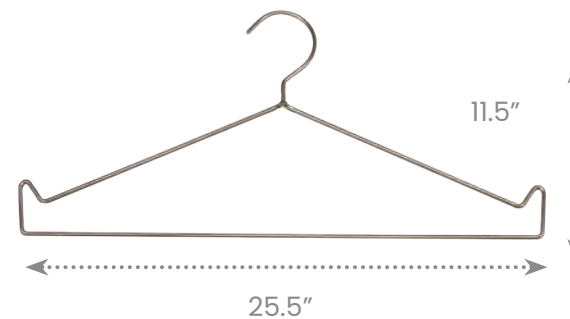

MIGHTY MAX RACK

MODEL: [AS-MAX-MOB]

CAPACITY: 10 APRONS

The Mighty-Max mobile apron rack's solid steel design holds up to 10 aprons. The pedestal base has rolling wheels for easy portability. Convenience hooks on each hanger can hold lead skirts.

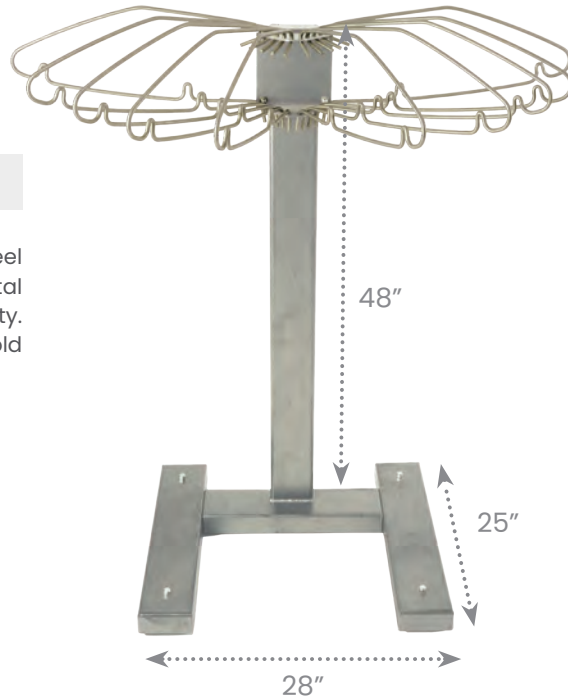

PORTA RACK

MODEL: [AS-PORTRK]

CAPACITY: 8 APRONS

Ideal for use in the O.R., Specials, and Cath Labs, this portable apron storage unit is great quality and affordable. The 24" wheel base with double casters allows this completely loaded rack to glide smoothly while being moved. The porta rack features moving hanger arms that swing forward and backwards for easy apron selection.

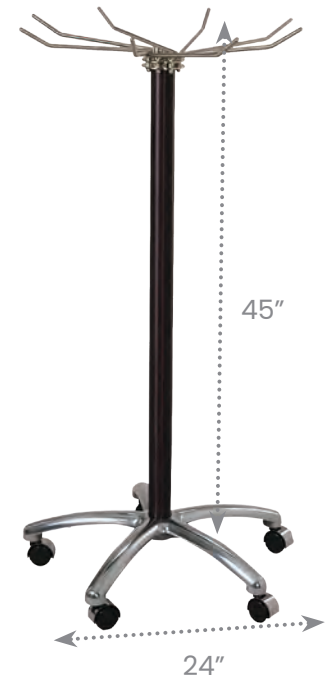

PEG RACK

MODEL: [AS-PEG]

CAPACITY: 1-10 APRONS

The apron Peg rack is made of steel construction and easily screws into wall studs. It can store up to 10 aprons but comes in a variety of sizes that accommodate a range of lead aprons. This affordable wall storage for aprons is essential to prolong the life of your protective aprons. *Mounting hardware is not included.

Example configuration shown: PEG-8

Model	# of Pegs	# of Aprons	Dimensions
PEG-2	2	1	5 x 3"
PEG-4	4	2	10 x 3"
PEG-6	6	3	15 x 3"
PEG-8	8	4	20 x 3"
PEG-10	10	5	25 x 3"
PEG-14	14	7	35 x 3"
PEG-18	18	9	45 x 3"
PEG-20	20	10	50 x 3"

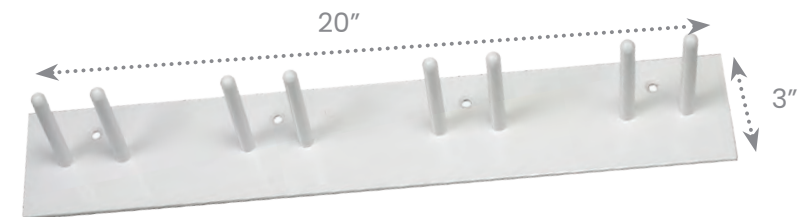

2-TIER VALET RACK

MODEL: [AS-VALET2]

CAPACITY: UP TO 10 APRONS

Industrial quality steel construction and medical-grade casters makes the 2-tier apron racks an excellent portable storage option. The rack provides storage capacity for up to 10 aprons. *Includes 4 screws for quick assembly

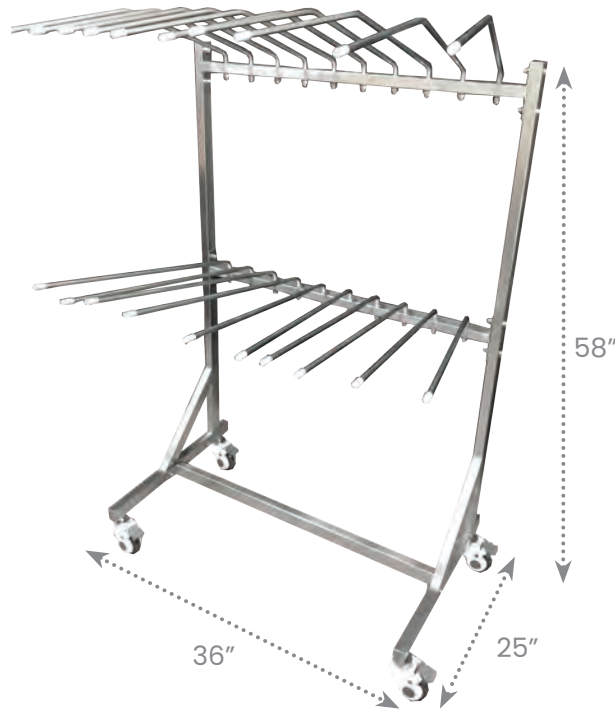

VALET RACK

MODEL: [AS-VALET1]

CAPACITY: UP TO 15 APRONS

Industrial quality steel construction and easy roll casters make these mobile apron racks an excellent portable storage option. The rack provides storage capacity for up to 15 aprons. *Includes 4 screws for quick assembly



WALL RACK

MODEL: [AS-WALL-L/R]

CAPACITY: 5 APRONS PER CONSOLE

Prolong the life of your radiation protective garment with our apron wall rack console. Each console holds up to 5 protective aprons with the combined left and right consoles storing up to 10 aprons. The wall console features hooks on the top of the hangers for lead skirts. *Does not include mounting hardware.

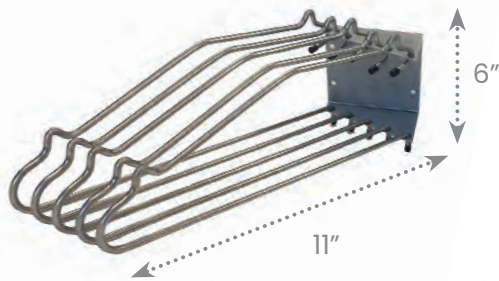

WIRE STORAGE LOCKER

MODEL: [AS-WLOCK3624]

CAPACITY: UP TO 15 APRONS

The Wire Storage Locker allows you to keep your garments and other valuables secure with the option of easy transport throughout your facility. The locker features lockable doors (opens a full 270°), 2 Wire Shelves, and a hanging rod (not shown) to easily hang your radiation apparel. The locker is coated with a true powder-epoxy over zinc-chromate electro-plating, ensuring a strong, durable finish with excellent handling of extreme temperatures and moisture. NEXGard®, an anti-microbial agent protects the epoxy coating from bacteria, mold, and mildew that causes odors and product degradation. Handles all environmental conditions. Some assembly required.

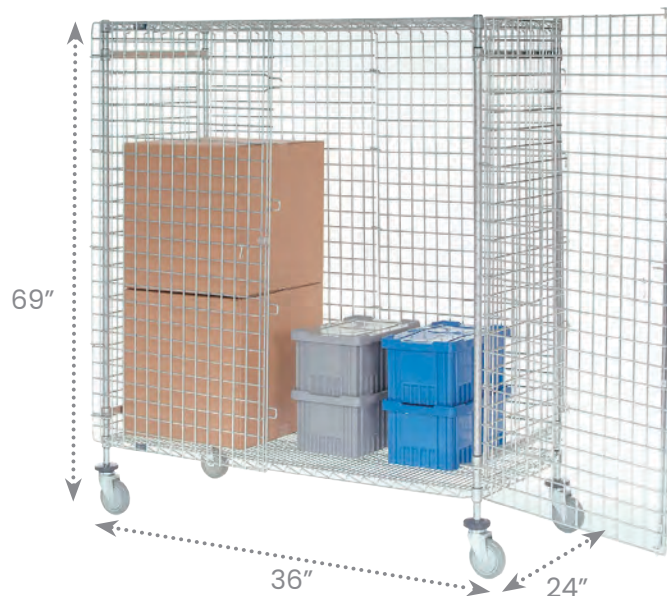

Z-RACK

MODEL: [AS-VALET3]

CAPACITY: UP TO 20 APRONS

Our Z-Rack is made with heavy duty construction and can hold up to 500 pounds. Large, swivel casters (2 with locking mechanisms) and convenient, nesting design make the Z-rack an excellent portable storage option. The rack provides storage capacity for up to 20 aprons!



APRON MEASUREMENTS

THE PERFECT FITTING APRON

Having a well-fitted apron is critical for comfort, optimized protection and garment longevity. An apron that's too big will leave you with gaps in protection. An apron that's too small will leave you uncomfortable and restrict movements during procedures. With that in mind, be sure to take a good look at our measuring instructions and size charts to determine your optimal size!

While most people can fit into a standard size apron, some will need a custom fit due to their unique proportions. For those looking for a tailor-fitted apron, Protech pride's itself on making some of the best in the industry.

Please review the following apron size charts and measuring guides. Once you've made all your measurements, you can contact us at 561.627.9769 or sales@protechmed.com. A representative will get back to you with more information.

Nervous about getting it right? Contact us! We have sales reps all around the world that can assist you.

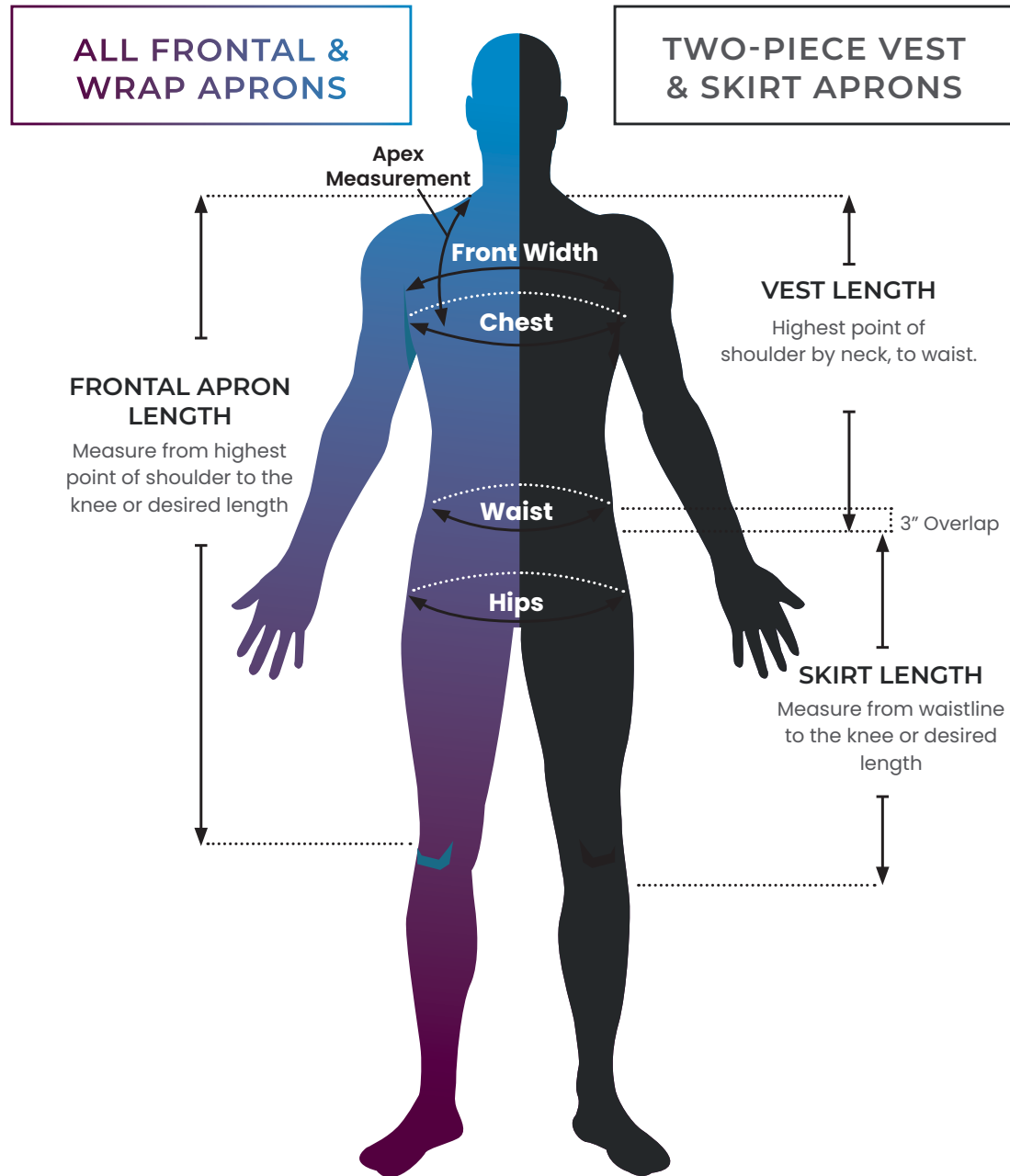



CHEST MEASUREMENT

Measure around the largest circumference of the bust area, keeping the tape parallel to the floor with the client's arms at their sides.

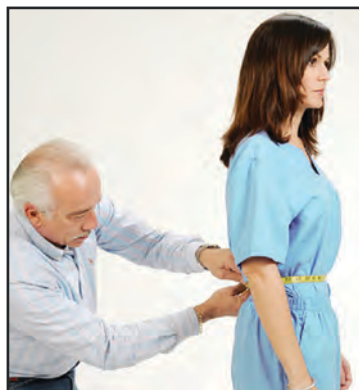

WAIST MEASUREMENT

Measure around the smallest circumference of the torso. If you measure at waist level it may be inaccurate.



HIP MEASUREMENT

Measure around the largest circumference of the hips and buttocks with the tape parallel to the floor: generally 8-9 inches down from the waist.



FRONT APRON LENGTH MEASUREMENT

Measure from the top of the shoulder over the bust to the desired length. Do not contour the tape measure in under the bust.



VEST LENGTH MEASUREMENT

Measure from the top of the shoulder over the bust to the desired length. Do not contour the tape measure under the bust.



SKIRT LENGTH MEASUREMENT

Measure from the top of the pant line (waist) and over the outside of the hip down to the desired length.



APEX ADJUSTMENT

Measure from the top of the shoulder (towards the neck) over the bust to the nipple. The apex measurement determines whether adjustments need to be made to the shoulder area. This helps to avoid shoulder gapping or tight arm holes in your apron. For example, a male large height of 5'10" may be fitted into a 3X due to their measurements. This would likely result in excessive shoulder material. Therefore, an apex adjustment of -1" would be applied.

WOMEN

GENERAL APRON SIZING

	XS	Small	Med	Large	XL	2XL	3XL
Height	5'1"	5'2"	5'5"	5'8"	5'10"	5'11"	
Chest	36	38	40	43	46	49	52
Waist	25	27	29	32	35	40	44
Hips	35	37	39	42	46	48	52
Frontal Length	33	34	36	38.5	40.5	42.5	42.5
Frontal Width	18	19	20	21	23	24	26
Vest Length	19	22	22	22	22	23	23
Skirt Length	20	20	22	22.5	22.5	22.5	24
WABR Length	33	34	37	40.5	42.5	42.5	44.5

TRI-TAB APRON SIZING

	Small	Med	Large	XL	2XL
Chest	38	40	43	46	49
Vest Length	22"	22"	22.5"	23"	26"

General Instructions

Standard sizes shown above apply as upper limits. If your measurements fall above a size's specified limit, we recommend you size up for additional allowance, aka "wiggle room." There is NO standard size allowance added so we recommend that you incorporate an additional 1-2" of "wiggle room" for the Chest measurement.

Length Adjustments

Length adjustments vary depending on your height and the required length adjustment to ensure your apron reaches around your knee cap. Any additional inches (up to 6") incur extra fees.

MEN

GENERAL APRON SIZING

	XS	Small	Med	Large	XL	2XL	3XL
Height	5'2"	5'4"	5'8"	5'11"	6'2"+		
Chest	39	42	45	49	53	57	61
Waist	32	34	38	42	46	50	54
Hips	34	36	40	44	48	52	56
Frontal Length	34	34	37	40.5	42.5	42.5	45.5
Frontal Width	19	21	22	24	26	28	30
Vest Length	22	22	24	25	25	25	28
Skirt Length	20	20	20	21	21	22	22
WABR Length	36	36	38	40.5	42.5	42.5	45.5

TRI-TAB APRON SIZING

	Small	Med	Large	XL	2XL
Chest	42	45	49	53	57
Vest Length	25"	27"	27.5"	28.5"	28.5"

Custom Sizing Allowances aka "Wiggle Room"

- All Styles XS to XL, by default, will be made with a +1" allowance in the Chest + Skirt waist- aka "wiggle room."
- All Styles 2XL to 4XL, by default, will be made with a +2" allowance in the Chest + Skirt waist - aka "wiggle room."
- If you do not want "wiggle room", you must specify.

Quality Assurance Size Tolerances

For all apron styles, our allowed size tolerances are -0 (no underage) up to +1".

ADDITIONAL MEASUREMENTS

THYROID COLLAR SIZING*

	Small/Reg.	Med	Large	XL
Original & Standard Thyroid	13-14"	15-16"	17"+	Custom
Proguard Thyroid	21"	22"	23"	24"
SG Disposable Thyroid	13-16"	-	17-20"	-
Visor Thyroid	25"	-	27"	-
Bib & Mammography Thyroid	One size fits all			

*Measurements of neck circumference

HEAD CAP SIZING*

	Small	Med	Large	XL
Head Cap	21"	22"	23"	24"
Page Cap	21"	22"	23"	24"
Proguard Smart Cap	21-22"		23-25"	
SG Disposable Smart Cap	21"	22"	23"	-

*Measurements of head circumference

KIDS APRON SIZING*



	Small	Medium	Large
Dimensions	12 x 24"	14 x 26"	16 x 28"
Ages	Ages 1-3	Ages 4-6	Ages 7-10

*Velcro Adjustable & Tie Aprons

APRON SLEEVE SIZING

	Small	Med	Large	XL	2XL
Length (Regular)	11"	11"	11"	11"	11"
Length (Short)	8.5"	8.5"	8.5"	8.5"	8.5"
Circumference (Female)	15"	15"	16-17"	16-17"	17-18"
Circumference (Male)	15"	16-17"	18-19"	19-20"	19-20"

APRON FABRIC COLORS

CHOOSE FROM HUNDREDS OF FABRIC COLORS!

Whatever your style, We have hundreds of fabric colors to chose from .



PERFORMANCE FABRICS



COOLGUARD FABRICS*

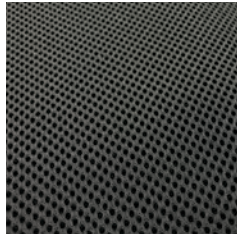

Coolguard Air
#900

A cushiony mesh material that enables natural air ventilation. Interior only.

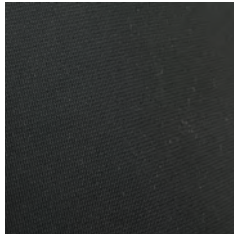

Coolguard Spandex
#915

Sweat wicking, breathable microfiber with quick dry technology.

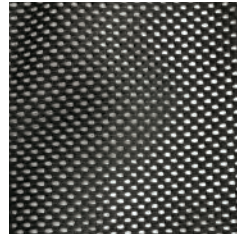

Coolguard Mesh
#910

Increases air flow on back closure of apron. For frontal apron back closures only.



Indigo
#925

A soft, PVC nylon that is fluid-proof, stain resistant, bacteria & fungus resistant. Our lightest-weight fabric!

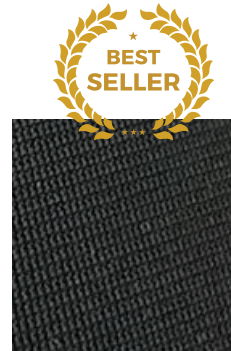

"Black Silk"
#920

Ultra-soft & breathable polyester that is fluid proof & stain resistant.

Anti-slip fabric
#950

A high-quality, textured fabric placed on the inside of your apron to prevent slippage.

SATINGUARD ANTI-MICROBIAL FABRICS*



Featuring stain resistant and anti-microbial technology only available from Protech. Our soft poly material will resist a wide variety of bacteria for several years.



Matte Black
#800



Matte Bordeaux Red
#824



Matte Cyan
#805

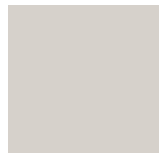

Matte Light Gray
#815



Matte Dark Gray
#813



Matte Lilac
#817



Matte Navy
#820



Matte Fuschia
#810



Matte Royal
#802



Matte Dark Teal
#828



Matte Light Teal
#830

*Upcharge applies

LIMITED EDITION FABRICS

2024 LIMITED EDITION PRINTS*



Athletic Department
#2200



Balloon Animals
#2205



Black Camo
#2210



Blue Steel
#2215



Bone to be Wild
#2220



Coral Gardens
#2225



EKG
#2230



Feline Fine
#2235



Green & Brown Camo
#2240

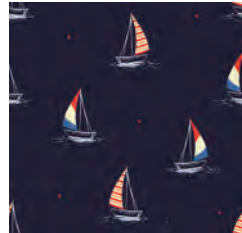

The Hamptons
#2245



Hitting the Green
#2250



Kyoto Cranes
#2255



Life's a Beach
#2260



Masked Heros
#2265



Painted Flowers
#2270

2023 LIMITED EDITION PRINTS*

- PHASE OUT -



Ankara Cloth
#2000

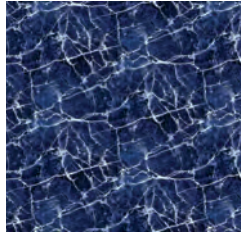

Blue Marble
#2010



Body Positivity
#2015

- PHASE OUT -



Exhaust-ed
#2020



Galactic Kitties
#2025

- PHASE OUT -

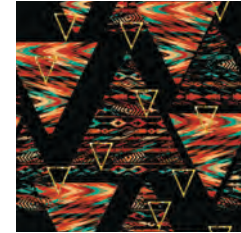

Geo Tribe
#2030



Grind my Gears
#2035

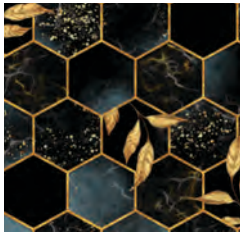

Hex Yeah!
#2040



Medically Necessary
#2045

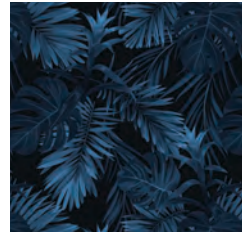

Midnight Jungle
#2050



Party 'Till You're Dead
#2070



Reel Time
#2075



Stable Genius
#2080



Stardate: 2022
#2022



Starry Night
#2090



Supernova
#2095



This Lead is
Bananas #2005



Tropical Smoothie
#2100

*Upcharge applies

NYLONS

Unless specified otherwise, nylons come standard 210 denier.



Black
#100



Burgundy
#105



Forest Green
#110

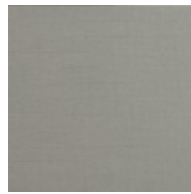

Gray
#115



Green
#120



Hot Pink
#125



Marine Blue
#135



Navy
#140

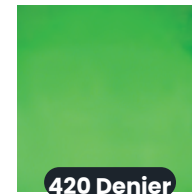

Neon Green
#145



Orange
#150



Purple
#155

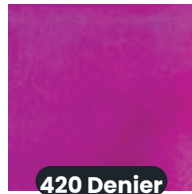

Raspberry
#160



Red
#165

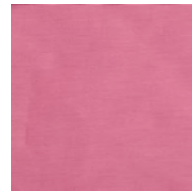

Rose
#170



Royal
#175



Tan
#180



Teal
#185

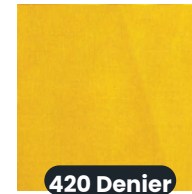

Yellow
#190

BINDING COLORS



Black



Gray



Tan



Burgundy



Red



Orange



Yellow



Neon Green



Green



Forest Green



Dark Teal



Light Teal



Marine Blue



Royal



Navy Blue



Purple



Raspberry



Hot Pink

RIPSTOP



Black
#200



Brown
#205



Burgundy
#210



Chocolate
#215

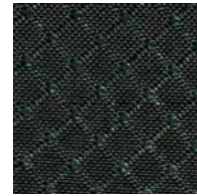

Forest Green
#220

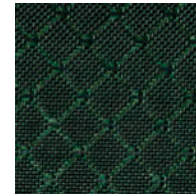

Green
#225



Navy
#230

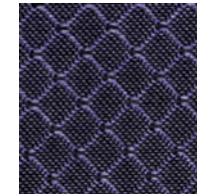

Purple
#235

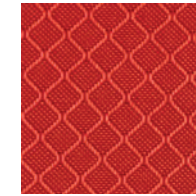

Red
#240



Royal Blue
#245

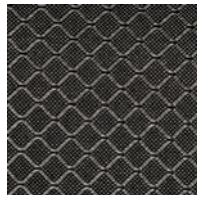

Silver
#250

WIPE-AWAY VINYLS*

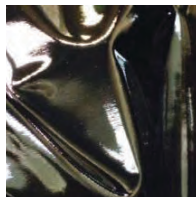

Black
#300

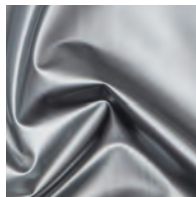

Silver
#320

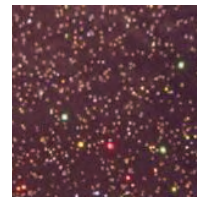

Burgundy
Starlight
#305

*Upcharge applies

CLASSIC PRINTS



70's Flowers
#400



Animal Farm
#405



Asian Garden
#415

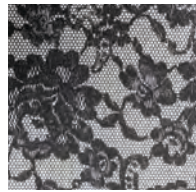

Black Lace
#417

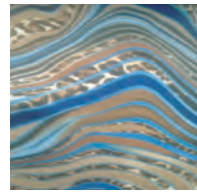

Blue Animal River
#420

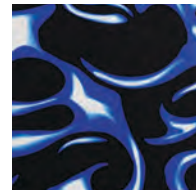

Blue Flame
#425



Brown Animal Spots
#435

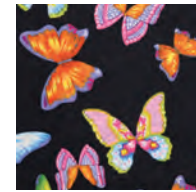

Butterfly
#440



Camo - Backwoods
#443

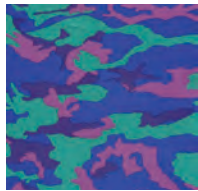

Camo - Cosmo
#450

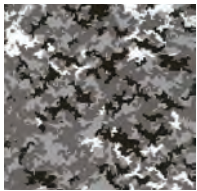

Camo - Digital Grey
#455



Camo - Pink
#465



Camo - Small Blues
#470



Camo - Small Pinks
#475



Camo - Yellow
#480

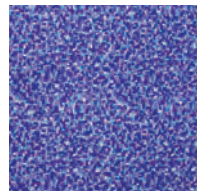

Chicklets Blue
#490

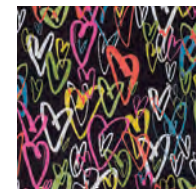

Crayon Hearts
#500

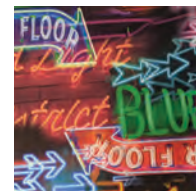

Divebar
#502



Dog Paw
#505



Fire Tongues
#510

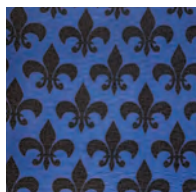

Fleur De Lis
#512



Fruity Pebbles
#515



Galaxy - Multi
#520



Galaxy - Royal
#525



Giraffe - Brown
#530

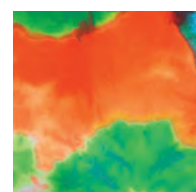

Green Neon Tie-Dye
#540

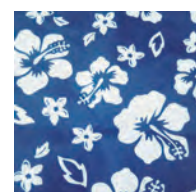

Hawaiian
#545



Hawaii Postcard
#550

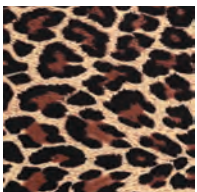

Leopard Print
#560



Lu Lu Grape
#565

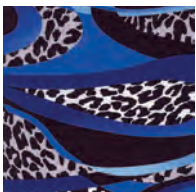

Mamba - Blue
#575



Mamba - Pink
#580

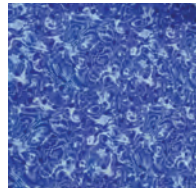

Marble Splash
#585



Mardi Gras
#590



Mystery - Multi
#595

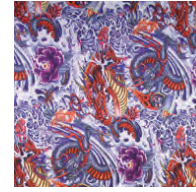

Painted Dragon
#600

CLASSIC PRINTS

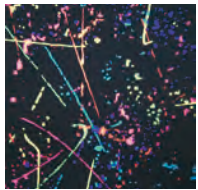

Paint Splash
#605

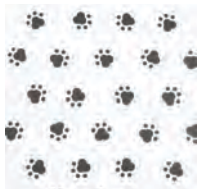

Paw Prints
#610



Plaid - Blue
#615



Plaid - Green
#620



Plaid - Light Pink
#625



Plaid - Purple
#630



Plaid - Tan
#635



Plaid - Teal
#640



Purple Neon
Tie-Dye #645



Rainbow
#650

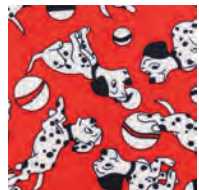

Red Dalmatian
#655



Sheep
#665

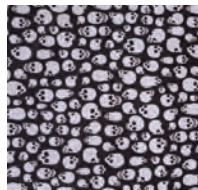

Skulls - Gray
#670

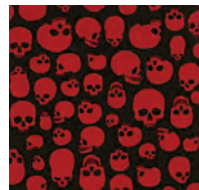

Skulls - Red
#675



Snake Skin
#680

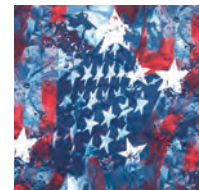

Star Gazer
#685

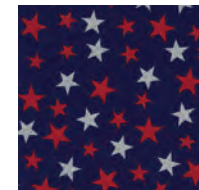

Stars
#690



Steel
#695

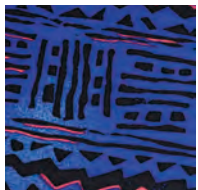

Surf Wax
#705



Teal Splash
#710



Tiger
#715



Zebra
#720

*Upcharge applies



Karen Brown
Chief Executive Officer

☎ 406.551.5216

✉ info@ForestImaging.net

🌐 www.ForestImaging.net